

Arbeitskreis  
Käfigaufbereitung  
(Working Group for Cage  
Processing)

**6th issue 2020**

# **CAGE PROCESSING**

## **in Animal Facilities**

properly done

**New  
6th issue  
2020**

**AK  
KAB**

You can download this brochure in PDF format for free on the following webpage's:

<http://www.gv-solas.de/index.php?id=41>

[www.felasa.eu/about-us/library](http://www.felasa.eu/about-us/library)

Member companies' homepages

Copyright 2020 Arbeitskreis Käfigaufbereitung AK-KAB (Working Group for Cage Processing).

All rights reserved.

(For members' addresses please refer to page 2.)

No part of this brochure may be reproduced in any manner without written permission from the AK-KAB (Working Group for Cage Processing).



# **CAGE PROCESSING in Animal Facilities**

**properly done**

**Arbeitskreis Käfigaufbereitung AK KAB  
(Working Group for Cage Processing)**

**6th issue 2020**

## Manufacturers of processing machines and items for processing:

**Florian Kellner-Fendt (chairman)**  
c/o TECNIPLAST Germany GmbH  
82383 Hohenpeißenberg  
Phone: 08805 / 921 32 0  
Fax: 08805 / 921 32 99  
Email: florian.kellner-fendt@tecniplast.de

**Johannes Bräutigam**  
c/o Dustcontrol Germany GmbH  
Lazarus-Schwendi-Straße 44  
79238 Kirchhofen  
Phone: 07633 / 929 08 68  
Fax: 07633 / 929 08 69  
Email: johannes.braeutigam@dustcontrol.de

**Dr. Martin Bönisch**  
c/o MMM Group GmbH  
Sammelweisstraße 6  
82152 Planegg  
Phone: 089 / 899 18 359  
Fax: 089 / 899 18 53 59  
Email: martin.boenisch@mmmgroupp.com

**Hans-Peter Popp**  
c/o IWT s.r.l / TECNIPLAST Germany GmbH  
82383 Hohenpeißenberg  
Phone: 08805 / 92132 0  
Fax: 08805 / 92132 99  
Email: hans-peter.popp@tecniplast.de

**Mischa Scheuer**  
c/o BELIMED Life Science AG  
Zelgstrasse 8  
CH-8583 Sulgen, Switzerland  
Phone: 0221 / 93 72 66 97  
Email: mischa.scheuer@belimed.com

## Manufacturers of process chemicals:

**Ina Haacke (vice chairman)**  
c/o Chemische Fabrik Dr. Weigert GmbH & Co. KG  
Mühlenhagen 85  
20539 Hamburg  
Phone: 040 / 789 60 313  
Fax: 040 / 789 60 120  
Email: ina.haacke@drweigert.de

**Thomas Altmann**  
c/o Ecolab Deutschland GmbH  
Ecolab-Allee 1  
40789 Monheim am Rhein  
Telefon: 02173 / 599 17 29  
Fax: 02173 / 59989696  
Email: thomas.altmann@ecolab.com

## Operators:

**Dr. Heinz Brandstetter**  
c/o Max Planck Institute of Biochemistry  
Am Klopferspitz 18  
82152 Martinsried  
Phone: 089 / 8578 2256  
Fax: 089 / 8578 2808  
Email: brandste@biochem.mpg.de

**Prof. Dr. med. Rene H. Tolba (until 2019)**  
c/o University Hospital Aachen, Institute of Laboratory Animal Science  
Pauwels Straße 30  
52074 Aachen  
Phone: 0241 / 80 80 472  
Fax: 0241 / 80 82 462  
Email: rtolba@ukaachen.de

## Hygienists:

**Prof. Dr. Ulrich Junghannß (until 2018)**  
c/o Anhalt University of Applied Sciences  
Department 7 – LFG Microbiology  
Bernburger Straße 55  
06366 Köthen  
Phone: 03496 / 67 25 34  
Fax: 03496 / 21 20 81  
Email: ulrich.junghannss@bwp.hs-anhalt.de

## Guests:

**Prof. Dr. Christine Baumgartner**  
c/o Klinikum Rechts der Isar der Technischen Universität München

**Mario Nemes (starting from 2021)**  
c/o Hobart GmbH  
Offenburg

**Nadine Sündermann**  
c/o Zoonlab GmbH  
Castrop-Rauxel

## Advisory collaboration:

**Dr. Heinz-Peter Scheuber**  
c/o GWT -  
Gesellschaft für wissenschaftlichen Tierschutz mbH  
Truderinger Straße 287  
81825 München  
Phone: 089 / 42024 833  
Fax: 089 / 42024 850  
Email: peter.scheuber@gwt-de.de

**Martin Scheer (chairman from 2005 until 2018)**  
c/o Tecniplast Germany GmbH  
82338 Hohenpeißenberg

We would like to express our gratitude to all former AK KAB members, who have not been mentioned above; for their efforts to create and continuously enhance the AK KAB brochure.

## Index

<b>1</b>	<b>Introduction</b> .....	<b>6</b>
<b>2</b>	<b>Cage processing cycles</b> .....	<b>7</b>
<b>3</b>	<b>Items for processing</b> .....	<b>8</b>
3.1	Product overview .....	8
3.2	Materials for processing .....	9
3.2.1	Plastics .....	9
3.2.2	Stainless steel .....	10
3.3	Information on item design .....	10
<b>4</b>	<b>Cage processing procedure</b> .....	<b>10</b>
4.1	Transport and storage systems .....	10
4.1.1	General requirements of transport and storage systems .....	10
4.1.2	Examples of commonly used transport and storage systems .....	11
4.1.3	Materials .....	12
4.1.4	Design and construction .....	12
4.2	Emptying components .....	13
4.2.1	Cage dumping .....	13
4.2.1.1	Hygienic aspects .....	13
4.2.1.2	Handling of dirty bedding .....	13
4.2.1.3	Design of bedding disposal stations .....	13
4.2.1.4	Different ways of dumping cages – advantages / disadvantages .....	14
4.2.2.1	Design of bottle emptying stations .....	16
4.2.2.2	Different ways of emptying water bottles – advantages / disadvantages .....	16
4.3	Washing / Rinsing / Drying .....	16
4.3.1	Washer requirements .....	16
4.3.1.1	Machine types and their common design .....	17
4.3.1.1.1	Cabinet cage washers .....	17
4.3.1.1.2	Tunnel cage washer .....	18
4.3.1.1.3	Cage and rack washers .....	19
4.3.1.1.4	Bottle washers .....	20
4.3.1.2	Process steps of typical washing procedure .....	21
4.3.1.3	Technical components .....	22
4.3.1.4	Documentation .....	25
4.3.2	Requirements of process chemicals .....	25
4.3.2.1	Process chemicals .....	25
4.3.2.1.1	Detergent .....	25
4.3.2.1.2	Neutraliser .....	25
4.3.2.1.3	Rinse aid .....	25
4.3.2.2	Characteristics and physical parameters .....	26
4.3.2.2.1	Material compatibility .....	26
4.3.2.2.2	Dispensing and concentration .....	26
4.3.2.2.3	Temperature .....	26
4.3.2.2.4	Replacing the detergent .....	26
4.3.2.3	Documentation and safety .....	26
4.4	Filling components .....	26
4.4.1	Cage filling .....	26
4.4.1.1	Hygienic aspects .....	26
4.4.1.2	Handling of clean bedding .....	26
4.4.1.3	Design of bedding dispensers .....	27
4.4.1.4	Bedding dispensing systems – advantages / disadvantages .....	27
4.4.1.6	Bedding trading unit .....	28
4.4.2	Filling of water bottles .....	29
4.4.2.1	Processing of drinking water .....	29
4.4.2.2	Design of bottle fillers .....	29
4.4.2.3	Bottle filling systems – advantages / disadvantages .....	29
4.5	Steam sterilisation .....	30
4.5.1	Requirements for steam sterilisers .....	30

4.5.1.1	Products and materials .....	30
4.5.1.2	Devices and procedures .....	30
4.5.1.3	Dimensions .....	31
4.5.1.4	Technical components.....	31
4.5.2	Special requirements on process validation.....	32
4.5.2.1	Initial situation regarding standards: .....	32
4.5.2.2	Operational qualification (tests with empty chamber): .....	32
4.5.2.3	Performance qualification (tests with load): .....	33
4.5.2.4	Sterilizing goods which require special attention: .....	33
4.5.2.5	Recommendations for test cycles: .....	33
4.6	Reduction of microorganisms on heat-sensitive products by means of hydrogen peroxide (H <sub>2</sub> O <sub>2</sub> ) / peracetic acid (PAA).....	33
4.6.1	Material lock .....	34
4.6.2	Requirements of processing procedures by means of H <sub>2</sub> O <sub>2</sub> .....	34
4.6.2.1	Basic lock types for H <sub>2</sub> O <sub>2</sub> gassing .....	34
4.6.2.2	Constructional requirements .....	35
4.6.2.2.1	Mechanical structure .....	35
4.6.2.2.2	Procedural components .....	35
4.6.2.2.3	Electrical structure.....	35
4.6.2.3	Processual requirements .....	36
4.6.2.4	Processual documentation .....	37
4.6.3	Requirements of processing procedures by means of peracetic acid.....	37
4.6.3.1	Constructional requirements .....	38
4.6.3.1.1	Mechanical structure .....	38
4.6.3.1.2	Procedural components .....	38
4.6.3.1.3	Electrical structure.....	38
4.6.3.2	Processual requirements .....	38
4.6.3.3	Processual documentation .....	38
<b>5</b>	<b>Requirements of facility construction .....</b>	<b>39</b>
5.1	Distribution of responsibilities.....	39
5.2	Requirements of utilities and utility systems .....	39
5.2.1	Water, softened water, and demineralised water .....	39
5.2.2	Steam .....	40
5.2.2.1	Heating steam .....	40
5.2.2.2	Clean steam .....	40
5.2.2.3	Requirements of heating steam and clean steam .....	41
5.2.3	Condensate.....	41
5.2.4	Compressed air.....	41
5.2.5	Electricity.....	42
5.2.6	Network connection for remote access and diagnostics .....	42
5.2.7	Wastewater .....	42
5.2.8	Process exhaust air.....	42
5.2.9	Heat dissipation.....	43
5.3	Construction dimensions, load-carrying capacity, and pit .....	43
5.4	Maintenance access and service room.....	43
5.5	Dispensing station for process chemicals .....	43
5.6	Installation data and consumption data .....	44
<b>6</b>	<b>Operation and Use .....</b>	<b>45</b>
6.1	Influence of planning on operation .....	45
6.2	Start up of operation.....	46
6.3	Handover.....	47
6.4	Operating staff.....	47
6.5	Machine log.....	47
6.6	Operator guide .....	47
6.7	Standard operating procedure (SOP) .....	47
6.8	Setting the procedural parameters.....	47
6.9	Routine checks and measures.....	49
6.10	Check of washing, drying, and steam sterilisation result .....	49
6.11	Maintenance measures.....	49

<b>7</b>	<b>Performance evaluation checks for washing systems</b> .....	49
7.1	Requirements.....	49
7.1.1	Washing.....	49
7.1.2	Decontamination.....	49
7.1.3	Rinsing.....	49
7.1.4	Drying.....	50
7.2	Test procedures for washing and decontamination of cages, racks, and wire lids.....	50
7.2.1	Setup of test strips and test parameters.....	50
7.2.1.1	Cage bases.....	50
7.2.1.1.1	Number of test strips per cage base.....	50
7.2.1.1.2	Test setup.....	51
7.2.1.2	Wire lids.....	51
7.2.1.2.1	Number of test strips per wire lid.....	51
7.2.1.2.2	Test setup.....	51
7.2.1.3	Racks (cage racks as well as storage and transport racks).....	51
7.2.1.3.1	Number of test strips per rack.....	51
7.2.1.3.2	Test setup for IVC racks.....	52
7.2.1.3.3	Test setup for storage and transport racks.....	52
7.2.1.4	IVC filter tops.....	52
7.2.2	Test procedures for evaluating the washing of cage bases, wire lids, and racks.....	53
7.2.2.1	Producing the test soiling.....	54
7.2.2.2	Test strip for cleaning evaluation.....	54
7.2.3	Test procedures for evaluating the decontamination of cage bases, wire lids, and racks.....	54
7.2.3.1	Test organism.....	54
7.2.3.2	Test strip for decontamination evaluation.....	54
7.2.3.3	Contamination.....	54
7.2.3.4	Evaluation of test strips.....	55
7.3	Test procedures for washing and decontamination of water bottles.....	55
7.3.1	Washing.....	56
7.3.1.1	Producing the test soiling.....	56
7.3.1.2	Applying the test soiling.....	56
7.3.2	Decontamination.....	56
7.4	Test procedure for confirming the rinsing of cage bases, wire lids, racks, water bottles, and bottle caps.....	57
7.5	Test procedures for drying of cage bases.....	57
7.6	Types of test procedure.....	59
7.6.1	Tests at the manufacturer's site (type test).....	59
7.6.2	Test after assembly.....	60
7.6.3	Periodic inspection on site.....	60
7.6.4	Extraordinary inspection.....	61
7.7	Bottle caps.....	61
7.8	Sustainability inspection.....	61
<b>8</b>	<b>Ecological requirements</b> .....	61
<b>9</b>	<b>Potential defects and damages in items for processing</b> .....	63
9.1	Material haze (when using polycarbonate).....	63
9.2	Material haze (when using polysulfone and polyphenylsulfone).....	63
9.3	Deposits.....	64
9.4	Stress / micro cracks.....	65
9.5	Deformations.....	65
9.6	Damage to plastic goods due to the use of unsuitable autoclave bags.....	65
9.7	Corrosion/pitting/extraneous rust in stainless steel (AISI 304, AISI 316).....	66
9.8	Problems during treatment of the bottle drinking nipples.....	67
9.9	Criteria for screening damaged material.....	68
<b>10</b>	<b>Literature, standards, publications</b> .....	69
<b>11</b>	<b>Terms / Definitions</b> .....	70
<b>12</b>	<b>Appendix</b> .....	75

## 1 Introduction

In animal facilities, a wide range of different items including cages, cage lids, wire grids, bottles, bedding, feed, transport trolleys, steam sterilisation containers, work clothes, and other equipment needs to be processed. Technical quality is essential for a safe and efficient processing procedure. It is also important that the selected systems can be handled conveniently and all individual components interact smoothly.

Usually, a centrally located wash-up area (processing centre) is the place where the processing is done.

An automatic processing is generally to be preferred to manual washing as it is more efficient and provides better options for standardisation and monitoring. Whilst this manual provides some information on manual washing its focus is on automated processing to reflect this preference.

Taking into account the complexity of processing combined with potential interface issues, standardising the procedure and defining constructional requirements of processing systems is vital. They underpin the high hygienic standards required for the above-mentioned items.

When designing cages, the first and most crucial factor to consider is the animal. Further requirements are defined by occupational health aspects and economically efficient workflows. Since the predominant biomedical research models are rodents and rabbits, this brochure puts its emphasis on items especially designed for these species.

In the meantime, the working group for cage processing has also dealt with the processing of aquatic housing systems. As the requirements and the resulting recommendations differ considerably from cage reprocessing, these have been published in a separate booklet of the working group on cage reprocessing entitled "FISH TANK PROCESSING in Animal Facilities properly done" in the 1st edition 2020.

The AK-KAB have made it their aim to provide a manufacturer-neutral guideline for planning, procuring, and operating processing systems and single processing components, and thus wish to address planners, manufacturers, and operators alike.

The following chapters provide information on:

- Cage processing cycles
- Requirements of items for processing
- Cage processing procedure
- Constructional requirements
- Operation and operating
- Performance evaluation checks for washing systems
- Ecological requirements
- Potential defects and material damages
- Literature, standards, publications
- Terms / definitions

In the 2<sup>nd</sup> issue of this brochure, the AK-KAB have added the chapters "4.6 Reduction of microorganisms on heat-sensitive items by means of hydrogen peroxide (H<sub>2</sub>O<sub>2</sub>) / peracetic acid (PAA)" and "7. Performance evaluation checks for washing systems".

In the 3<sup>rd</sup> issue, all of chapter 7 has been revised, and the guidelines for checking washed water bottles for cleanliness have been completed. The 4<sup>th</sup> issue received a complete revise and update, emphasizing on chapter "4.2 Emptying components"; "4.4 Filling components", and "9.6 Problems during treatment of the bottle drinking nipples.

Focus of the new 5th edition was the state-of-the-art-update of chapter „4 Cage processing procedure“. Chapter „4.5.2 Special requirements on the process validation“ was added to specify sterilisation-requirements and the new part „12 Appendix: Self-declaration concerning checkable attitudes of washing machines“ should further help during purchase decision phases.

In the 6th edition, the text was adapted and the chapters were revised according to the latest state of the art. In chapters 4.5 and 4.6, for example, the further developments in chamber dimensions for sterilisers and H<sub>2</sub>O<sub>2</sub> material locks were updated. In chapters 4.5 and 6.11, supplementary instructions for periodic checks of sterilisation and cleaning results were included to ensure the



system functions according to the recommendations of the AK KAB. In chapter 7.4, the inspection of the rinsing performance of a washer was described in more detail and supplementary acceptance criteria were defined. Chapter 7.8 now also contains information on the possible review and evaluation of the processes according to certain sustainability criteria. Chapter 9 contains further information on changes to plastic materials, steam sterilisation of goods in sterilisation bags and the possibility of recycling measures for discarded reprocessed goods.

You will find information on legal restrictions, regulations, work safety aspects, as well as on the Guidelines of the Society of Laboratory Animal Science (GV-SOLAS).

NOTE:

This version is the translation of a German brochure. Therefore it refers to the cage processing procedures and normative standards that are usually given in Germany.

## 2 Cage processing cycles

The following figure shows the interaction of components and functions when cages are processed in the wash-up area:

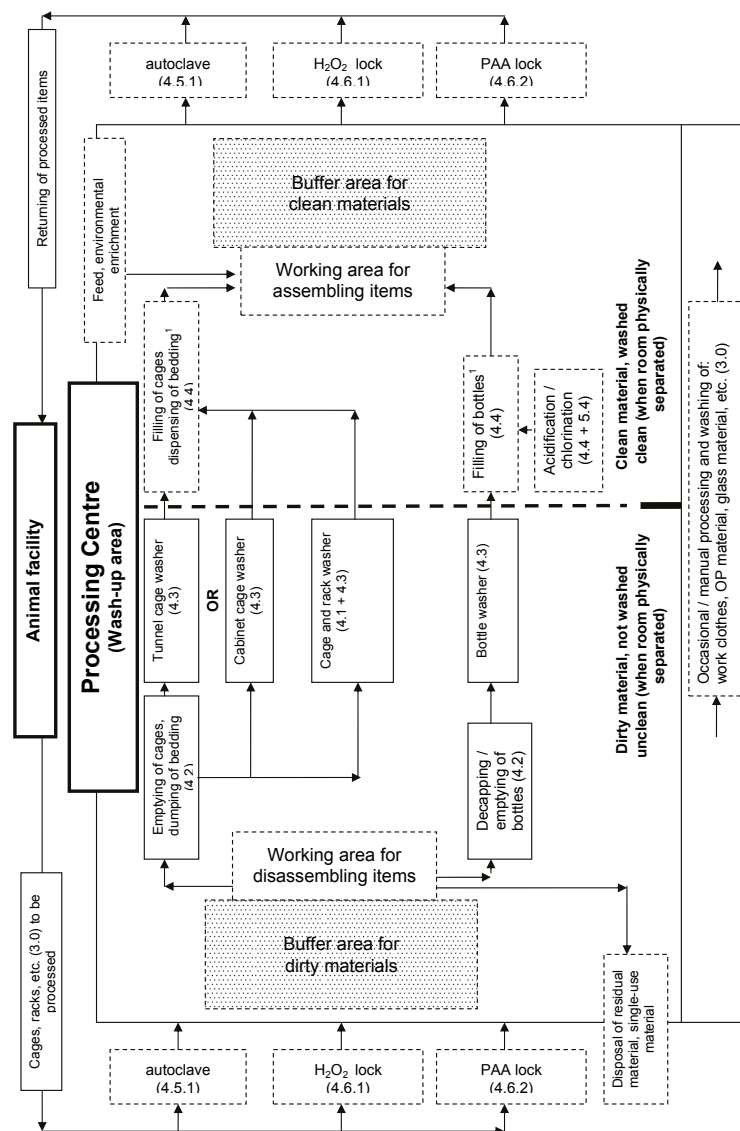

Fig. 2-1 Cage processing cycle

Note: Dashed boxes indicate optional steps of the processing cycle, which can – but don't have to be integrated within the cage processing cycle.

<sup>1</sup> Immediately after washing or immediately after returning into the animal facility.

### 3 Items for processing

Now that the processing cycle (Chapter 2) has been shown, the items to be processed in this procedure are described below. Information will be provided on material, range, and design. Automatic processing will be the main focus.

#### 3.1 Product overview

Below you will find a list of items commonly used for automatic processing:

Table 3-1

Plastics	Stainless steel
Cage base for rodents	Metal cages
Filter tops (with filter sheet) for open cages	Wire lids and wire floors
(Filter) tops for IVC cages	Dividers
Airflow components for IVC systems	Bottle caps
Water bottles	Card holders
Card holders	Cage racks for open cage systems
Cage base and waste trays for rabbits	Cage racks for IVC systems
Environmental enrichment (can be made of wood)	Airflow components for IVC systems
Supply and transport containers for feed/bedding	Storage and transport racks
Metabolic cages	Mobile work and laboratory benches
Injection tubes	Supply and transport containers for feed/bedding
Crates for water bottles and accessoires	Diet hoppers
	Crates for water bottles and accessories

**Please note:** Other than shown in this table, it may be necessary to process the above described items manually for either technical reasons (special cage) or economic reasons (low utilisation or lack of funding).

Usually, the following (heat-sensitive) items undergo a manual processing only (please refer chapters 4.5 and 4.6):

Table 3-2

IVC fan units
Animal cage changing stations
Ventilated cabinets for animal cages
Biosafety cabinets
Bedding disposal stations

Listed below are optional items for animal facilities. Information on processing them can be found in other publications, for example in "Instrumenten-Aufbereitung im Veterinärbereich richtig gemacht", „grüne Broschüre“ "Proper Maintenance of Instruments in Veterinary surgeries", please refer to chapter 10:

Table 3-3

Endoscopes
Surgical instruments
Textiles
Glass material
Components for automatic watering systems
Operating tables
Computers
Microscopes
Power tools

## 3.2 Materials for processing

When defining what is required of an item in order to be processed, individual facts and circumstances must be considered regarding its mechanical, thermal, and chemical resistance, as well as how often the material is handled.

Below you will find a description of commonly used materials and their most important characteristics:

### 3.2.1 Plastics

The following plastics are generally used:

- Polycarbonate (e.g. Makrolon®)
- Polysulfone
- Polyetherimide
- Polyphenylsulfone
- Polypropylene
- Polystyrene
- Polyphenylene oxide (e.g. Noryl®)
- Composites (e.g. fibreglass reinforced material, Trespa® or Polyphthalamides (PPA))
- Miscellaneous materials for wheels and casters (please refer to chapter 4.1)

In rodent cages, it is usually polycarbonate, polysulfone, polyetherimide, and polyphenylsulfone. The table below indicates the individual characteristics of these plastics:

Table 3-4

	Steam sterilisable up to <sup>1</sup>	Comment <sup>1</sup>
Polycarbonate	121 °C	<ul style="list-style-type: none"> <li>• transparent, clear, or slightly tinted</li> <li>• regular autoclaving may cause degradation of material (please refer to chapter 9)</li> <li>• alkaline residues may cause problems (please refer to chapter 9)</li> </ul>
Polysulfone	134 °C	<ul style="list-style-type: none"> <li>• transparent, slightly tinted</li> <li>• suitable for frequent autoclaving</li> <li>• physically and chemically high-resistant</li> <li>• unsuitable rinse aids may cause problems (please refer to chapter 9)</li> </ul>
Polyetherimide	143 °C	<ul style="list-style-type: none"> <li>• transparent, amber-coloured</li> <li>• suitable for frequent autoclaving</li> <li>• physically and chemically very high-resistant</li> </ul>
Polyphenylsulfone	143 °C	<ul style="list-style-type: none"> <li>• transparent, slightly tinted</li> <li>• suitable for frequent autoclaving</li> <li>• physically, chemically, and mechanically very high-resistant</li> </ul>

**<sup>1</sup>Please note:** The above-mentioned data is meant to be a rough guideline. For product-specific questions, please refer to the manufacturers' instructions.

The following advice might be useful:

- When steam sterilising filled water bottles made of polycarbonate, a temperature lower than 121 °C is preferred (e.g. 118 °C) in order to avoid deformation. It is also possible to prolong the autoclaving time (please refer to chapter 4.5.1.2, table 6-3, and chapter 9.4).

- When transferring cages with dirty bedding out of a barrier area by means of autoclaving, the cages should be made of either polysulfone, polyetherimide, or polyphenylsulfone (please refer to chapter 4.5.1). This also applies for cages filled with highly resinous bedding (please refer to chapter 9.1).
- When autoclaving and where the release of bisphenol A is not permitted or wanted, processing items made of polycarbonate is to be avoided.

### 3.2.2 Stainless steel

Stainless steel is often used and well suited for processing items in animal facilities. Usually, so-called “V2A-steels” are used (AISI 304). What is essential, in all cases, is the machining and working of the steel, especially the pre-machining and finishing of welds and surfaces.

Stainless steel, however, can be damaged when in contact with chlorines (e.g. hydrochloric acid, please refer to chapter 9.5).

## 3.3 Information on item design

You will find a detailed description of required cage dimensions in the guidelines of the GV-SOLAS and the Appendix A of the European Council, ETS 123 (please refer to chapter 10). Therefore, dimensions will not be discussed here. Please note, however, the following advice regarding the design of items for processing:

- Sharp edges are dangerous for humans and animals; they can be avoided by careful deburring.
- Cavities are difficult to clean and should be avoided, for example, hollow section structures should be fully welded.
- In the case of pipes through which air flows (e.g. IVC cage racks with ventilation pipes), their inner sides must be accessible during cleaning due to the arrangement and function of the **spray nozzles** of the washer.
- “Cavities” should be avoided, without causing functional limitations.
- A joint-free design is recommended in order to avoid dirt traps (hygiene) and capillary action (drying).
- Flat surfaces are recommended for easy cleaning and drying.
- Ergonomic aspects should be considered, for example the use of 18 bottle crates instead of 36, bottle crates made of plastic or the use of height-adjustable cage changing stations.
- Items should be stackable for effective use of transport and storage space.
- The design of the items should be maintenance-friendly, for example filters and other components to be maintained should be easily accessible.

## 4 Cage processing procedure

### 4.1 Transport and storage systems

Usually, in order to be washed and sterilised, all items are transferred into and out of the animal housing area. The items are moved constantly and therefore they should be easy transportable in all areas (animal rooms, hallways, processing centre) and usually dedicated for temporary storage. Hence, the same systems should be used inside and outside the animal housing area. The items are moved with so-called transport and storage trolleys that case by case pass through the same washing and if applicable steam sterilisation process parallel to the other items. This should be considered when planning the capacity and design of washers and sterilisers.

Below you will find a description of general requirements, some examples of transport and storage trolleys, as well as design, construction and materials.

#### 4.1.1 General requirements of transport and storage systems

To ensure a smooth workflow, transport and storage systems used in animal facilities should meet the following requirements:

- Transport and storage trolley systems should match the total facility layout (doors, lifts, washers, sterilisers, and locks) as well as the items to be processed (please refer to chapter 3).
- For a better planning, the capacity required for transport, storage, and steam sterilisation should be ex-

amined in advance. When selecting suitable transport and storage trolleys, the manufacturers of those should be contacted for assistance.

- They should be easy, convenient and save to handle.
- They should also be able to undergo the same washing and steam sterilisation process as the items to be processed and should be resistant to the applied detergents and disinfectants (please refer to chapter 9).
- The trolley systems should be designed for universal use, for storage, transport, and loading of steriliser and lock. An optional function might be that they can be used as work benches. The advantages are as follows: After being washed, there is no need for the items to be transferred to another trolley for steam sterilisation. So the number of different trolley types can be reduced. If the available sterilisers and locks are not designed for floor level access, special small loading trolleys can be used, as well.

#### 4.1.2 Examples of commonly used transport and storage systems

Table 4-1

Types	Common dimensions (hxwx in mm)	Transport and storage of
Universal transport / storage trolley	1500 - 1900 x 500 - 600 x 1000 - 1500	various items, e.g. stacked open cage bases and wire lids, or closed cages, etc.  feed and/or bedding bags  water bottles in crates; accessories
Special cage transport / storage trolley	1500 - 1900 x 500 - 1000 x 1000 - 1500	closed cages; allows for a safe and contamination-free transport of some cage types
Special bottle transport / storage trolley	1500 - 1900 x 500 - 700 x 1000 - 1500	water bottles in suitable crates made of stainless steel or plastic; stable design adequate for the required capacity
Special feed transport / storage trolley	1500 - 1900 x 500 - 600 x 1000 - 1500	feed in suitable containers (racks, perforated metal shelves, etc.)



Fig. 4-1 Examples of universal transport / storage trolleys

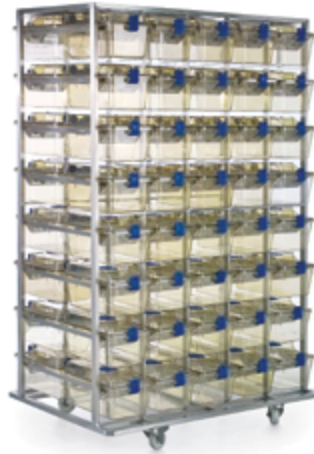

Figure 4-2 Example of a special cage transport / storage trolley



Figure 4-3 Example of a special bottle transport / storage trolley, for bottle crates made of stainless steel and / or plastic



Figure 4-4 Example of a special feed transport / storage trolley

### 4.1.3 Materials

Due to high mechanically, thermally, and chemically induced material strain, especially during washing and steam sterilisation, stainless steel is a material often used and well suited (please refer to chapter 3.2.2) for transport and storage trolleys.

For wheels and fenders (collision protection) following plastics are adequate.

- Glass-fibre reinforced Nylon® (soft, smooth running)
- Bakelite® (harder, louder rolling noise, but thermally more resilient)
- Polyphenylsulfone (very high thermal and chemical resistance, durable and high stability, smooth running).

### 4.1.4 Design and construction

Depending on their type of use, the following important aspects should be considered when designing transport and storage systems:

- Wheels and fenders must be thermally and chemically resistant in order to avoid degradation during washing, disinfection, and steam sterilisation.
- The total structure, and wheel structure in particular, need to withstand the process-induced stress during washing, disinfection, and steam sterilisation (maximum stress must be calculated).
- Perforated and/or inclined surfaces are recommended in order to minimise water puddles during washing

- and/or steam sterilisation and to make items easily accessible for steam.
- Height-adjustable shelves ensure a flexible use.
  - Special bottle trolleys (e.g. with open bars instead of closed sides) allow for better ventilation and achieve a faster regulation of the temperature balance during steam sterilisation (heating-up, cooling-down).
  - Wheels, handbrakes, and fenders, as well as other movable parts (wear parts) should be easy to replace.
  - In case elevators are used for transportation, king-sized wheels are required (diameter 100 mm or more) to avoid getting stuck in the gap between elevator and floor. Huge gaps should be avoided because of job safety and wheels protection.

In addition to that, please pay attention to the information given on design in chapter 3.3.

## 4.2 Emptying components

To minimise the amount of dirt being carried over to the washing chamber, water bottles and cage bases in particular need to be emptied prior to being washed as described in chapter 4.3. There are different ways of emptying cages and bottles. Generally, cage bases are emptied of dirty bedding, possibly mixed with disposable enrichment products and feed pellets. In bottles, there is usually just water residue left.

Below you will find a description of components that allow for a convenient, efficient, and, most important, safe emptying of cages and bottles.

### 4.2.1 Cage dumping

#### 4.2.1.1 Hygienic aspects

Dirty bedding can pose several potential health issues: Danger of infections caused by exposure to animal excrements, as well as a danger of generating allergens caused by proteins transported on dander, hair and excrements.

Also the dust of certain wood types can cause allergies. Some of these wood dusts are even classified as carcinogenic (please refer to chapter 4.4.1.5).

Another important aspect to consider is the human musculoskeletal system. Constant repetitive work like manual dumping of cages often leads to muscular tensions and chronic afflictions of the back, neck and shoulder area.

The impact of repetitive working processes on operating staff like manual dumping of cages and the preventive measures (arrangement of the cage, installation of automatic systems like robots) have been investigated in scientific studies ( see publications chapter 10).

#### 4.2.1.2 Handling of dirty bedding

When handling cages, gloves, suitable respiratory masks, and suitable work clothes should always be worn. Transport trolleys with cages to be emptied as described in chapter 4.1 should be moved adjacent to the dump station and locked there.

Environmental enrichment that is to be reused and/or not suited to the bedding disposal system must be removed before a cage is emptied, unless the dumping device is adequately dimensioned for these articles or equipped with a suitable shredder. If there is excrement or bedding left after a cage has been emptied and knocked out, it should be removed with a soft scraper. This leads to a better cleaning result and less dirt being carried over to the washer.

#### 4.2.1.3 Design of bedding disposal stations

For a convenient, staff-friendly workflow, unnecessary stacking and moving of items should be avoided. Therefore, it is recommended to set up the disposal station in line with the washer to aid work flow. Avoiding major torso twists and long transport distances is not only ergonomic, but also timesaving. There should be sufficient room for a temporary storing of stacked cages. This room can either be created by considering the space local to the disposal station or by using side tables.

**Size:** Ergonomic working heights are set between approximately 800 and 900 mm, depending on the local situation. Reasonable dimensions of a dumping area often range between 800 x 800 and 1000 x 1000 mm (lxw), depending on the dimensions of the cages used.

**Structure:** The disposal station or elements connected to the waste collection bin or conveyor tube should have sealed surfaces to avoid dirt traps. A grid, bar, or similar device allows for an easy knocking out and setting down of cages. For a convenient cleaning, such devices should be detachable.

**Material:** Stainless steel (material AISI 304 or more significant) offers a major advantage regarding durability and cleaning.

**Cleaning:** Disposal stations should be easy to clean and be designed accordingly. A general cleaning should be done daily, an intensive cleaning weekly (either manually or automatically, depending on the design).

**Components for shredding and disposal of environmental enrichment / feed pellets:**

Depending on the design of a disposal station, solutions for shredding of the enrichments and feed pellets (e.g. shredder) must be taken into consideration. The purpose is to avoid clogging of subsequent parts of the processing system (e.g. press or conveyor tube). Functional reliability of a shredding unit and its suitability for the products to be shredded should also be considered.

Most importantly of course, such supplementary equipment must be safe to handle for the operating staff. Thus, openings must be safe, and designed to prevent particles from escaping or being ejected (please refer to Machinery Directive 2006/42/EC, formerly known as 98/37/EC).

**Components for preventing dust and allergens:**

Taking measures to avoid dust and allergen exposure is most important for the health protection of the operating staff. Such measures should be taken for every exposed area (e.g. disposal station; collection bins for bedding, dust, and waste in general). In addition to technical and/or organisational dust prevention, an efficient particle reduction can be achieved with a suitable suction device and is generally to be preferred to personal protective equipment (e.g. respiratory masks). The following particle suction devices are technically possible:

- Negative pressure between dumping- and bedding collection room (in cases of dumping hopper with large down pipe)
  - Less effective, high requirements on the ventilating system and relocation of the dust problem
- Rim ventilation on the dumping station
  - Less effective
- Small or large suction hood ("cross-flow hood")
  - Highly effective, reasonable costs of purchase
- LAF-tent solution (down flow)
  - Highly effective, high space requirements and high costs of purchase

Previous devices should guarantee a strong and effective front air barrier (air suction into the work aperture at operator level), in order to avoid the release of aerosols during cage dumping (referring to requirements of cage chaging station, TRBA 120).

**Please note:**

Dust-reduced bedding does help. However this does not lower the concentration of allergens carried on animal hair, danders, etc.

#### 4.2.1.4 Different ways of dumping cages – advantages / disadvantages

In the table, below you will find options for a manual, semi-automatic, and fully automatic emptying of cages:



Table 4-2

	Option	Advantages	Disadvantages
Manual systems (without dust suction)	direct dumping into disposal bags or containers	cost-effective; can be realised within an existing system; flexible	time-consuming; dust exposure; unpleasant smell; low capacity
Manual systems (with suitable dust suction device)	dumping via dumping hopper into a disposal room beneath;	no manual transportation of waste bedding from the wash-up area (timesaving); reduced fine dust exposure; less unpleasant smell; high capacity;	can usually not be realised within an existing system; dust exposure in the disposal room;
	dumping cabin where cage contents are dumped into disposal bags or containers, with suitable dust suction device	reduced fine dust exposure; flexible	time-consuming (limited ergonomics); unpleasant smell; low capacity
Semi-automatic systems	dumping hopper or dumping cabin with pneumatic bedding conveyance into an external collection bin	no manual moving of items from the wash-up area (timesaving); reduced fine dust exposure; less unpleasant smell; high capacity	complex fitting into an existing building; relatively cost-intensive
Fully automatic systems	fully automatic emptying with help of robots or machines with pneumatic waste conveyance into an external collection bin	no manual moving of items from the wash-up area; timesaving; ergonomically beneficial; reduced fine dust exposure; less unpleasant smell; high capacity; reduced staff possible	high costs of purchase, requires space; limitations possible due to necessary standardisation; high maintenance



Fig. 4-5 Example of a manual system: dumping cabin where cage contents are dumped into disposal bags or containers, with suitable dust suction device

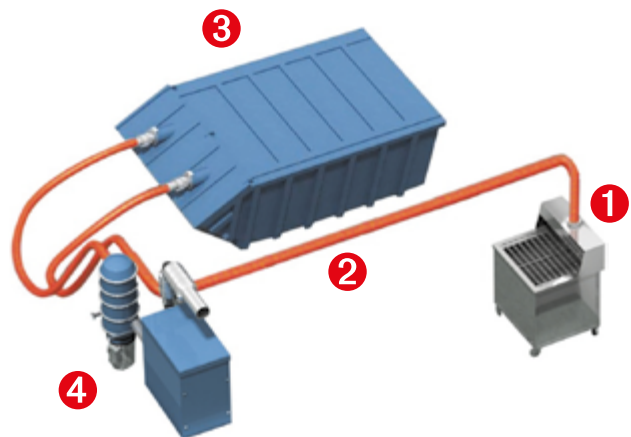

Fig. 4-6 Example of a semi-automatic system: dumping hopper or dumping cabin ① with pneumatic bedding conveyance with piping ② into an external collection bin ③; vacuum generator and dust filter ④

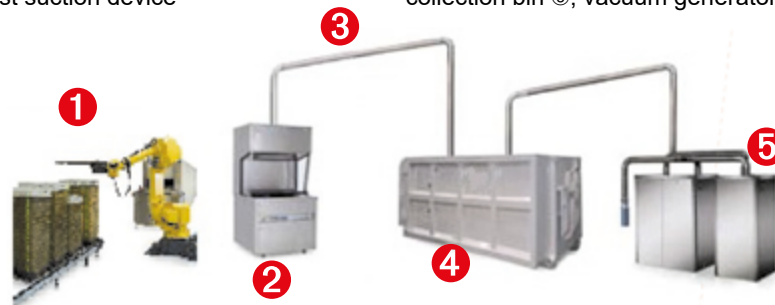

Figure 4-7 Example of a fully automatic system: automatic emptying with help of robots or machine ① into dumping hopper ②, with pneumatic waste conveyance with piping ③ into an external collection bin ④; vacuum generator and dust filter ⑤

## 4.2.2 Emptying of water bottles

Before water bottles can be washed, the bottle caps must be removed from the bottle necks. The open bottles will then be turned over in their crates in order to remove residual liquids. After that the washing chamber will be loaded with the bottles neck down.

### 4.2.2.1 Design of bottle emptying stations

For a convenient, staff-friendly workflow, unnecessary stacking and moving of items should be avoided. Hence, the emptying machine should be set up in a way that the washer can be loaded right after the bottles have been opened and emptied. Avoiding major torso twists and long transport distances is not only ergonomically reasonable, but also timesaving. Therefore, emptying stations can be designed and arranged “in a line” as part of the entire bottle processing station.

**Size:** Ergonomic working heights are set between 800 and 900 mm. This height is reasonable for this specific process depends on the bottle crate design. There should also be enough room for a temporary storing of bottle crates.

**Structure:** To collect residual liquids the emptying machine should be equipped with a basin of sufficient size. The basin dimensions must have enough space for baskets which collect the bottle caps. The work space should allow for a convenient handling and moving of bottle crates.

**Material:** Stainless steel (material AISI 304 or more significant) offers a major advantage regarding durability and cleaning.

**Cleaning:** Emptying machines should be easy to clean and be designed accordingly. A general cleaning should be done daily, an intensive cleaning of the entire machine weekly.

### 4.2.2.2 Different ways of emptying water bottles – advantages / disadvantages

Below you will find options for a manual, semi-automatic, and fully automatic emptying of water bottles:

Table 4-3

	Option	Advantages	Disadvantages
Manual systems	decapping of bottles with a special cap lifter; immediate dumping of liquids into a suitable sink	cost-effective; can be realised within an existing system; flexible	low capacity; ergonomically difficult, bottle drinking nipple / seal heavily stressed
Semi-automatic systems	automatic decapping of bottles (pneumatically or mechanically); immediate manual dumping of liquids into a suitable sink	gentle decapping; can be realised within an existing system	costs of purchasing
Fully automatic systems	fully automatic decapping of bottles and dumping of liquids with help of robots or machines	timesaving; ergonomically beneficial; high capacity; reduced staff possible	costs of purchase; limitations possible due to necessary standardisation; high maintenance

**Note:** In the case of mechanical decapping (partially and/or fully automatic systems), care should be taken when selecting the system and function to avoid mechanical stress on the bottles and drinking caps and in particular on the nipples during the decapping process and to ensure a gentle process.

## 4.3 Washing / Rinsing / Drying

### 4.3.1 Washer requirements

The function of a washer in the wash-up area of an animal facility is to clean and, where necessary, decontaminate items (please refer to chapter 3) pursuant to operator-specific standards and conditions. The washing is done with suitable process chemicals, following an effective and standardised washing procedure that

usually consists of a recirculation of water and detergent and a subsequent fresh water rinsing, possibly with added rinse aid.

Below you will find a description of the most important machine types, process steps, and technical components:

### 4.3.1.1 Machine types and their common design

The different washer types that can principally be used are depicted in the cage processing cycle shown in chapter 2.

Table 4-4

	Common items to be processed	For small animal facilities up to 2000 cages type 2L <sup>4</sup> per week	For large animal facilities starting with 2000 cages type 2L <sup>4</sup> per week	Common dimensions of effective chamber area (hx-wxd in mm)	Common overall dimensions of the unit (hxwx d in mm)	Number of doors
Cabinet cage washer (as front loading chamber or chamber with hood)	cages, tops, wire lids, accessories (bottles in case of emergency <sup>5</sup> )	YES	NO	600 to 800 x ca 1300 x 600 to 800	1700 to 2000 <sup>1</sup> x 1400 to 1900 x ca 1000	1-D / 2-D
Tunnel cage washer	cages, tops, wire lids, accessories	NO	YES	300 to 700 x 600 to 1000 <sup>2</sup>	2100 to 2800 x 900 to 1400 x length <sup>3</sup>	-
Cage and rack washer	racks, cages tops, wire lids, accessories (bottles in case of emergency <sup>5</sup> )	YES	YES	ca 2100 x 900 to 1200 x 1800 to 3000	2500 to 3100 x 2200 to 3500 x 2300 to 3500	1-D / 2-D
Bottle washer without automatic decapper	water bottles	YES	NO	300 to 800 x 500 to 1300 x 500 to 800	1400 to 2000 x 600 to 1900 x 600 to 1000	2-D respectively passthrough
Bottle washer with automatic decapper and buffer zone	water bottles	YES	YES	300 to 800 x 500 to 1300 x 500 to 800	1400 to 2100 x 2600 to 3500 x 600 to 1000	2-D respectively passthrough

<sup>1</sup> Height when closed. Machines with vertically opened hood / door can measure up to 3000 mm.

<sup>2</sup> These dimensions describe the height and width of the pass-through section.

<sup>3</sup> The machine length depends on the required throughput and usually ranges between 7 m and 15 m.

<sup>4</sup> Cage type 2L: Common cage size for housing mice, dimensions approximately 365 x 207 x 140 mm (l x w x h).

<sup>5</sup> A general recommendation is, that for bottle washing specific bottle washers should be used. Bottle washing should be separated from washers where any cage parts are cleaned. However due to cost and capacity reasons it might be necessary, that cages AND bottles needs to be cleaned with one washer only. To avoid any particle cross contamination and carryover of particles during the process, suitable washers with special nozzles or special loading carts have to be selected. In addition accurate cleaning of the chamber, the nozzles and replacement of the washing tank water is to be considered.

#### 4.3.1.1.1 Cabinet cage washers

Below you will find common designs of cabinet cage washers:

- Washers with front doors (sliding or hinged doors)
- Washers with hoods that open upwards, for a three-sided opening



Fig. 4-8: Cabinet cage washer with hinged or sliding door



Fig. 4-9: Cabinet cage washer with hood (if applicable, extension of loading and unloading tables will be required)

The washers operate in wash cycle mode. They can be run with one or two doors (for example washers with pass-through sections where dirty and clean side are physically separated). The hoods or doors can be opened manually or automatically.

#### 4.3.1.1.2 Tunnel cage washer

Other than cabinet washers, tunnel washers operate in line. The items are washed in separated series of washing zones (for the respective process steps see chapter 4.3.1.2), thereby being conveyed on a belt from loading side to unloading side. Separation zones and plastic curtains amongst the washing zones are used to minimize the carryover of dirt and cleaning detergents in between the zones. The throughput as well as the cleaning and drying result is determined by the length of the zones and conveying velocity.



Fig. 4-10: Tunnel cage washer with separated series of zones

#### 4.3.1.1.3 Cage and rack washers

This machine type is the only one to combine cage washing with automatic washing of racks and other large-sized or bulky items. Therefore, these washers offer a floor level access (designed in a pit or with ramps).

The washers operate in wash cycle mode. They can be run with one or two doors (for example with a pass-through section where dirty and clean side are physically separated). The washer is available with wing hinged or sliding doors, which can be opened manually or automatically.



Fig. 4-11: Cage and rack washer

#### 4.3.1.1.4 Bottle washers

Bottle washers were particularly designed for washing water bottles and bottle caps. Normally the water bottles get refilled after the cleaning process immediately, so there is no need for a following drying process. To prevent bottle caps from being clogged with bedding particles, it is recommended to wash bottles and caps separately from cages in different machines. (Animals can die of thirst because of clogged bottle caps.)

In certain exceptional cases bottles may be washed in the same cage washer. This practice is only recommended if the nozzles and the chamber are properly cleaned and the washing tank water is replaced with fresh new water.

New and modern washers offer direct, quick and precise bottle washing e.g. through use of single nozzle technology for every single bottle position.

The process of cleaning the bottle caps should be considered with special care. Still common and often performed is random cap presentation in the crates. This set up particularly affects the inside of the cap nozzle, which is not completely flushed by the water jet. Furthermore the way of loading (random presentation) creates cavities and blind spots where water and detergent residues could be diverted. A solution could be the use of specifically designed bottle cap crates (see chapter 4.3.1.3 loading systems) or automatically by positioning each cap in such a way that it can be flushed individually.

Below you will find common designs of bottle washers:

- Washers with hoods that open upwards for a three-sided opening
- Washers with front doors (sliding or hinged doors)
- Washers with front doors or hood, with combined / or without automatic decapper and / or recapper

Bottle washers operate in wash cycle mode and they can be run with one or two doors (for example with a pass-through section where dirty and clean side are physically separated). The hoods or doors can be opened manually or automatically. These machines are usually combined with a preceding bottle emptying station with decapping of bottles (manual, semi automatic, fully automatic) and succeeded by a refilling station with recapping of the bottles (manual, semi automatic, fully automatic) (please refer to chapter 4.2.2 und 4.4.2).



Fig. 4-12: Bottle washer as pass-through application or with hood and benches, without automatic decapper



Figure 4-13 Bottle washer as pass-through application, with automatic decapper, bottle crate conveyance, washing, filling and recapper.



Figure 4-14 Full automated bottle washer as pass-through application, with loading from bottle crate trolley, decapper, bottle crate conveyance, washing, filling, recapper and loading into bottle crate trolley

### 4.3.1.2 Process steps of typical washing procedure

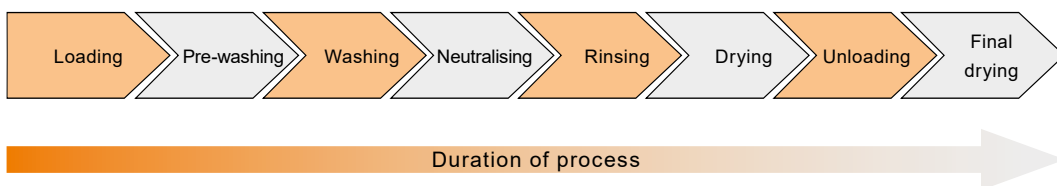

Figure 4-15 Necessary (orange) and optional (grey) steps of machine washing

#### Loading

Loading means, in case of cabinet, cage, and rack washers, that the items to be washed are placed on a loading trolley and moved into the washing chamber. This can also be done with semi- or fully automated systems, e. g. with automatic conveyorized belts or robotic systems. When using a tunnel washer, the items are placed on a belt. Some types of bottle washer – depending on the configuration - allow the loading of a whole crate with water bottles through an automatic conveyor belt or in combination with a robotic system into the decapping zone and on into the washing chamber (similar to tunnel washers). An optimal washing and drying outcome may require adherence to certain loading rules of the manufacturer of washer.

#### Pre-washing

Tunnel washers can include so-called pre-washing zones. In cabinet washers and cage and rack washers the same result may be achieved with a special pre-washing cycle.

In the case of heavily soiled (e.g. autoclaved) cages, mechanical pre-cleaning (e.g. by manual scraping with a soft plastic spatula) may be necessary.

### **Washing**

Hot water mixed with detergent (alkaline, pH neutral, or acid) is sprayed from a tank via jets onto the items to be washed. In cage and rack washers the detergent solution (also called detergent liquor) is collected in a tank beneath the chamber where it is pumped back into the washing tank. In cabinet and tunnel washers the water is collected in the washing tank placed underneath, where it is recirculated. Thus, the items can be sprayed with a high volume flow of water and detergent solution, making additional fresh water unnecessary during the washing phase.

Where required, it is possible to perform a series of washings, with for example alkaline and acid detergents. Therefore the washer must be equipped with several washing-tanks. Usually, the washing water solution is largely recirculated for the following loads to reduce the water consumption as much as possible. Approximately 4 - 7 percent of fresh water is routinely added.

To reduce the amount of water needed to rinse off the items, it might be helpful in cabinet washers and cage and rack washers to wait for the detergent solution to drip off first.

### **Neutralising**

To ensure there are no residues left, an item washed with alkaline detergents requires neutralisation. This can be achieved either by an immediate neutralisation step prior to the rinsing process or through using an acid rinse aid for the rinsing process. Neutralising is particularly important for polycarbonate (PC) cages in order to prevent the material from being damaged by alkaline residues in the steam sterilisation process.

### **Rinsing**

Residual detergent is removed with clear hot water that is sprayed via jets onto the washer load. A rinse aid (also acid rinser for neutralisation) can be added. To avoid lime scale or salt deposits it is recommended to use demineralised water. Polysulfone (PSU) requires material-specific rinse aids.

Detergent solution should not be mixed with rinsing water.

### **Drying**

The purpose of the drying process is to dry the items to an acceptable residual moisture.

With suitable rinse aids, added during the rinsing process, the items can dry faster after being removed from the chamber. Also for this type of washer heat recovery systems can be combined with a vapour exhaust conditioning system and heat pump.

In tunnel washers, the items are usually dried in a drying zone with ambient and / or hot air. This is a continuous process. The resulting vapours should be exhausted through integrated extraction hoods at the entry and exit area of the tunnel as well as in the rinsing zone. This central exhaust process can be combined with a heat recovery (if applicable in combination with a vapour exhaust conditioning system and a heat pump).

With cage and rack washers, hot-air can be used for the drying process. The aeration of the chamber removes the residual moisture from the load. In wash cycle-type machines, the drying can further be enhanced by feeding clean steam into the chamber. Also this type of washer heat recovery systems can be combined with a vapour exhaust conditioning system and heat pump.

For bottle washers, added rinse aid or a subsequent hot-air drying is not necessary, as, usually after washing, water bottles are refilled with drinking water.

### **Unloading**

Unloading of cabinet, rack, and bottle washers means that the loading trolleys or racks are removed from the chamber and cleared of the items. In case of tunnel washers, the belt is cleared and whilst unloading, a final drying outside the machine begins. The unloading can be done with semi- or fully automated systems e. g. automatic driven conveyerized belts or robotic systems.

### **Final drying outside the machine**

Stored heat in the washed items helps potential residual moisture to evaporate (drying by specific heat). This requires a sufficient heating of the items while being rinsed or dried inside the machine. Where necessary, pro-



visions should be made to prevent the operating staff from getting burnt by the specific material heat (e.g. setting up a final drying zone with warning notices; defining a minimum cooling time for a safe handling of items).

### 4.3.1.3 Technical components

#### Washing chamber

Every surface of the chamber that comes in contact with process liquids should be flat and have round corners. Blind spots and gaps should be avoided. To ensure the liquids can fully run off and no residues are left in the chamber, including the wash and rinse tanks, a sufficient surface incline should also be considered.

Apart from necessary devices like guide rails, spray arms, and spray water baffles, components that are not mandatory inside the chamber, like water pipes and pumps, should not be built in. For hygienic and maintenance reasons, these components should be placed outside the chamber.

To prevent dirt particles from penetrating the recirculation system, which might cause jet clogging, fine-meshed filters should be installed in the drain-off area. For cleaning purposes of these filters simple and easy access, – optimal from outside the chamber – should be possible. In new and modern washers self-cleaning filters are available, to process dirty particles continuously and automatically from the washing chamber into the drain.

Every junction, gasket or penetration of the sealed chamber must be resistant to the selected chemicals. Furthermore, all components should be made of stainless steel (material AISI 304 or higher) or suitable plastics in order to ensure their temperature and mechanical resistance.

The walls of the chamber as well as the wash and rinse tanks should meet the required standards of the German Institute for Standardization, DIN 4140.

The table below indicates required technical characteristics of a washing chamber:

Table 4-5

Cabinet cage washer Bottle washer	<ul style="list-style-type: none"> <li>• one or two loading levels</li> <li>• application of carrier systems (e.g. baskets and crates, etc.)</li> <li>• conveyORIZED belt for automated bottle processing in bottle washers</li> </ul>
Tunnel cage washer	<ul style="list-style-type: none"> <li>• belt, carriers, and runners made of stainless steel or plastic</li> <li>• device for circulating spray water back into the respective washing zone to prevent water carry over from one wash section to the next.</li> </ul>
Cage and rack washer	<ul style="list-style-type: none"> <li>• chamber floor designed for flexible use of loading trolleys with different track width</li> <li>• interior light</li> <li>• emergency stop button with door release in the chamber</li> </ul>

#### Wash and rinse tanks

The form, design, and choice of material wash and rinse tanks should meet the same requirements as the chambers. Depending on the machine type, the tanks can be placed beneath, above or next to the chamber. There might be several tanks needed, depending on the type of washing procedure and machine.

#### Jet systems

For a successful washing, the jet system is essential. It has to ensure that the load is covered with a sufficient amount of detergent solution. To avoid any unsprayed areas it is recommended to use oscillating nozzle arm technologies in particular for cabinet cage washers and cage and rack washers. It is recommended to operate with an individual jet system for bottle washing to achieve an accurate and faster cleaning result, which means every bottle will be cleaned using a single jet. The jets are usually made of stainless steel or plastics. They can either be fed through single or double pipe systems.

The following factors are decisive for a successful washing and rinsing process:

- number, arrangement, and design of jets
- spray pressure

- volume flow rate (e.g. litres per minute) of the detergent solution
- spray and tilt angle
- jet motion e.g. oscillating, rotary, linearly moved, or fixed
- cleaning-friendly jet systems, e.g. screwable jets, removable spray arms
- design of the nozzle / spray system with the lowest possible pump power consumption but large volume flow to achieve a high TTI value (TTI value, is the impulse of the water that impacts the surface of the material to be treated, definition and calculation see Chapter 11).

For the best possible washing outcome, the jet spray system, spray pressure and volume flow rate of the pumps must be adapted to the maximum capacity and dimension of heat exchanger, tanks, and dispensing devices. Only the correct combination will ensure an effective, safe, and repeatable procedure.

### **Loading systems**

In cabinet cage washers, the items are placed on different loading levels before being moved into the chamber. To ensure that all liquids drip off sufficiently, it is generally preferable to slightly tilt the items to be washed, and animal cages in particular. The variety of items to be processed usually requires item-specific carrier systems.

Cage and rack washers are loaded with special trolleys. Floor level access to the chamber allows for a convenient trolley maneuvering. To avoid spray shadows and to ensure an effective washing, the items on the trolleys must be fixed in a suitable position relevant to the nozzle positions inside the chamber. The variety of items to be processed usually requires item-specific racks.

Carrier systems and loading trolleys should be made of stainless steel (e.g. material AISI 304) or suitable plastics. Casters must be resistant to the chemicals and operating temperatures of the process. For hygienic reasons, cavities and blind spots should be prevented by a smart design.

The treatment of bottles caps should be organized in specific presentation frames to ensure a defined single arrangement of 18 to 36 caps. To prevent animals dying of thirst because of clogged bottle caps, the current usage of baskets with randomly accommodated caps should be avoided (see chapters 4.3.1.1.4 and 9.6). If this is not possible make sure to significantly reduce the number of caps per basket to prevent masking of nozzles. Moreover conduct a check of the correct function of the bottle nozzle before usage (see chapter 9.6).

Filter tops for IVC cages with cavities for external water bottles require special loading systems to ensure the liquids fully run off. Examples are as follows:

- crates or special loading levels to achieve tilted positioning of items in cabinet and tunnel cage washers
- special belt design for the correct placement of filter tops and other items in tunnel cage washers
- loading racks for tilted positioning in cage and rack washers

### **Machine shell**

The bodyshell of a washer should preferably consist of stainless steel with a conventional surface treatment. For maintenance purposes, the access to the service room should be of sufficient size to allow safe entry. The panelling to the room should consist of doors or should otherwise be easy to open and detach.

### **Service and maintenance area**

The service area of a machine is the enclosure where all necessary pumps, pipes, valves, tanks, dispensing devices, etc. are located. There are several ways to design this area, depending on the type of machine.

It is important that the built-in units are arranged clearly and are maintenance-friendly.

### **Process measuring and control technology**

#### *Machine control*

A washer should run a complete cycle automatically. The required cycle program is selected on a control panel at the loading side or at the machine control cabinet (e.g. keypad, touchscreen). It is recommended to build in programmable logic controllers (PLC) or microprocessor controllers. This allows for a change in process parameters.

#### *Displays and monitoring*

The washers should be equipped with control instruments and display the following parameters:

- operator-selected program
- selected parameters
- individual phases of the operating cycle
- remaining program time
- temperatures of detergent solution and rinsing water
- temperature within the chamber
- end of program when in wash cycle mode
- empty signal of the process chemical unit (canisters or barrels)
- notice of malfunction

#### *Remote access and diagnostics*

In order to be able to carry out a quick diagnosis by the manufacturer in the event of faults or malfunctions of the system, even without the presence of a qualified service technician on site, modern control systems with the possibility of external remote access via the internet should be used. For this purpose, the necessary hardware and software preparations as well as the network and firewall settings should be coordinated at an early stage with the in-house IT department with the involvement of the manufacturer. In the case of new buildings, it is advisable to determine this already in the planning phase.

#### *Safety-related components*

Washers must be designed with safety systems according to the VDE (German Association for Electrical, Electronic and Information Technologies) and meet the requirements of government safety organisations. They must further have the CE mark of conformity (please also see risk assessment of the operator in chapter 6).

Safety components include for example locking devices for chamber doors in order to prevent them from being opened mid-program. The purpose is to protect the operating staff and to prevent hazardous elements from leaking into the working rooms. Also an emergency release inside walk-in chambers is mandatory as well as a device for program interruption when the chamber is opened. An easily accessible emergency stop button should also be considered.

For tunnel cage washers an additional emergency stop on the loading and unloading side as well as a monitoring sensor at the end of the belt should be installed, so the belt will stop automatically, if the operator fails to remove an item in time.

#### *Control cabinet*

All electronic and control-related components as well as pushbuttons, signal lamps, etc. must be placed in a splash proof control cabinet with protection category IP 54 or higher. All electric utilities built in the service area must be designed according to protection category IP 54 or higher.

### **4.3.1.4 Documentation**

The documents accompanying a washer should be supplied in the language of the country the machine is delivered to and should consist of the following:

- operator guide with maintenance instruction and troubleshooting,
- wiring diagram,
- process and instrumentation drawing (P&ID),
- list of spare parts.

The supply pipes, disposal pipes, equipment, and other building measures required for these machines are described in chapter 5.

### **4.3.2 Requirements of process chemicals**

Process chemicals and their specific characteristics must suit the washer (and product) they are selected for. To avoid damages of load items and the washer itself, only chemicals that were developed specifically for washers and verified suitable for the washing process described must be used.

The chemicals are provided in liquid form and are dispensed automatically. Dispensing straight from the trading unit (e.g. canister, barrel or buffer / day tank) is recommended (see chapter 5.5).

In detail, process chemicals must meet the following requirements:

### 4.3.2.1 Process chemicals

The selected chemicals must fit the described technical conditions of a washer; they must not cause any excessive foam or deposits (please refer to chapter 4.3.1). The manufacturer's recommendations on the safety data sheet about the use of chemicals have to be considered, in order to avoid health hazards.

#### 4.3.2.1.1 Detergent

It is generally possible to use acid, pH neutral, and alkaline detergents as well as combinations of acid and alkaline detergents in suitable washers. For water bottles, acid detergents are recommended. Items and detergents must always be compatible.

#### 4.3.2.1.2 Neutraliser

Acid neutralisers can be used to help remove alkaline detergents. Depending on the application, those chemicals can help avoid water salt deposits.

#### 4.3.2.1.3 Rinse aid

Rinse aids should achieve an even and sufficient wetting of the different materials of a wash load. They can thus contribute to the drying process and help avoid spots and drops. Acid rinse aids are preferred because of the following reasons:

- De-activation of water hardness
- Neutralisation of alkalinity of the softened water
- Neutralisation of possible alkaline residues of the detergent

### 4.3.2.2 Characteristics and physical parameters

#### 4.3.2.2.1 Material compatibility

When used correctly, chemicals should not cause corrosion or other material damages within the manufacturer-stated life expectancy of the items that are processed (please refer to chapter 3).

#### 4.3.2.2.2 Dispensing and concentration

Process chemicals can be dispensed centrally or locally (please refer to chapter 5.5). Information on dosage is provided by the manufacturers on the trading unit labels. For detailed information, please refer to the corresponding data sheets.

Chemical manufacturers can further list methods for determining the correct concentration (+/- 10% of the set point, e.g. titration or conductivity measurement).

#### 4.3.2.2.3 Temperature

Chemicals must be adequate for the temperature range of a specific washing procedure, as recommended by the manufacturers of the items to be washed and machines to be used.

#### 4.3.2.2.4 Replacing the detergent

The detergent solution is to be regenerated or replaced as required. Depending on the items to be washed, the tanks, mesh filters, and jets must be checked regularly and cleaned daily if required (please refer to chapter 6) in order to achieve a satisfactory cleaning result.

### 4.3.2.3 Documentation and safety

For every process chemical, manufacturers must provide a data sheet and material safety data sheet. The

operator must then compile operating instructions. For rinse aids, manufacturers must provide a toxicological risk assessment.

## 4.4 Filling components

After washing, the cage bases are refilled with bedding as the bottles are with water. They are then returned into the animal facility. Cages and bottles can also be refilled in the animal rooms. This may require the bedding and water to be hygienically processed separately.

### 4.4.1 Cage filling

#### 4.4.1.1 Hygienic aspects

When cages are refilled, a fine dust of clean bedding can be released. Some wood types can cause allergies, whilst some are classified as carcinogenic. Even if not classified as dangerous, however, airborne fine dust is to be minimised and where necessary to be exhausted when occurring in the work place in order to protect the operating staff as best as possible. (Please consult the labour protection laws of your respective country/EU standards.)

Another important aspect to consider is the human musculoskeletal system. Constant repetitive work like manual filling of cages often leads to muscular tensions and chronic afflictions of the back, neck, and shoulder area (see publication in chapter 10).

#### 4.4.1.2 Handling of clean bedding

When handling clean bedding (usually at the bedding storage place or wash-up area), the following aspects should be considered:

- When handling cages, gloves, suitable respiratory masks, and suitable work clothes should always be worn.
- Open storage of bedding over a long period should be avoided.
- Dust should be avoided. A procedure-specific suction device is recommended.
- Ergonomic working heights of 800 to 900 mm are recommended.
- When handling bedding manually, light, small bags are to be preferred.
- When using big bedding bags, suitable technical applications, like a crane track with lifting tools and trolley drive must be provided.
- Bedding should only be moved with suitable transport systems and over the shortest possible distance.

#### 4.4.1.3 Design of bedding dispensers

For a convenient, staff-friendly workflow, unnecessary stacking and moving of items should be avoided. Hence, a bedding dispensing machine should be located in a way that the cage bases can be refilled immediately after they have been removed from the washer. This requires largely dried cages. For a best possible workflow, the transport systems described in chapter 4.1 should be moved adjacent to the dispensing machine and locked there. Generally, avoiding major torso twists and long transport distances is not only ergonomically reasonable, but also timesaving.

**Size:** When determining the dimensions of a bedding dispenser, current as well as future capacities and requirements should be taken into consideration.

**Material:** Stainless steel (material AISI 304 or higher) offers a major advantage regarding durability and cleaning.

**Cleaning:** Bedding dispensers should be easy to clean and be designed accordingly. A conventional cleaning should be done every day, an intensive cleaning of the entire machine every week.

#### 4.4.1.4 Bedding dispensing systems – advantages / disadvantages

Table 4-6

	Option	Advantages	Disadvantages
Manual dispensing	bedding is dispensed from bags or containers	cost-effective; can be introduced within an existing facility; flexible	time-consuming; high dust exposure; ergonomically difficult; low capacity; requires a manual transport of bedding from the bedding storage place
Semi-automatic dispensing*	bedding is dispensed by a constant curtain or mobile dispensing station	can be introduced within an existing facility; high capacity	major dust exposure; relatively high costs of purchase; requires a manual transport of bedding from the bedding storage place; heavy deposits of dust in the local area.
	mobile dispensing station with suitable dust suction device	can be introduced within an existing facility, medium high capacity; nearly no dust exposure, flexible	relatively high costs of purchase, requires a manual transport of bedding from the bedding storage place
	dispensing systems with vacuum transport, with suitable dust suction device	does not require a manual transport of bedding from the bedding storage place (timesaving); low fine dust exposure; can be introduced within an existing facility; high capacity; reproducible bedding quantities	relatively high costs of purchase
Fully automatic dispensing*	dispensing systems with vacuum transport and fully automatic handling by robots or automatic machines, with and without inverter technology for the cage body	does not require a manual transport of bedding from the bedding storage place; timesaving, ergonomically beneficial; low fine dust exposure; high capacity; reduced staff possible; reproducible bedding quantities	high costs of purchase; requires space; possible limitations due to the need to standardise cages; high maintenance

\*In semi and/or fully automated systems, the process capability of the bedding plays a key role. Hence, it is important to use fibre-reduced bedding (avoiding lightweight/fluffy materials) or to take technical measures inside the dispensing station in order to prevent the material from bridging. If no suitable technical measures can be taken, free flowing bedding types are to be preferred in order to reduce interruptions in the system and achieve a repeatable process.



Fig. 4-15 Example for a semi-automatic system: mobile dispensing station with suitable dust suction device

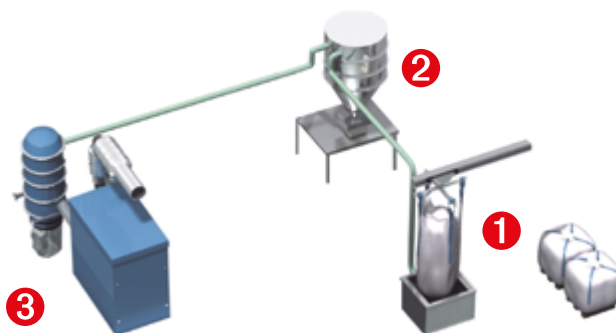

Fig. 4-16 Example for a semi-automatic system: hopper e. g. for BIG-Bags, and crane ①, dispenser with dust suction system ② and vacuum generator and dust filter ③ for pneumatic conveyance



Fig. 4-17 Example for an fully automatic system: Filling of cages by robots or automatic machines ①, loading hopper e. g. for BIG-Bags ②, optional storage silo ③, dispenser with dust suction system ④ and vacuum generator and dust filter ⑤ for pneumatic conveyance

#### 4.4.1.5 Potential health issues caused by bedding materials

When assessing potential health issues caused by bedding materials, not only the type of wood is to be considered, but also the size and geometry of the particles as well as the overall dust content. For further information, please refer to the pertinent literature available (e.g. EU Directive 2004/37/EC, appendix 1/5).

#### 4.4.1.6 Bedding trading unit

Bedding delivery can take place in three different types of trading units: Bags (10 to 15 kg), Big Bags or using tank trucks. It is recommended to use bags only in small facilities because of the time consuming workflow and the negative impact on the musculoskeletal system. Big bags are handled with technical applications, like a forklift and crane track. This combines ergonomics with time saving and features high capacity at a reasonable price. Silo solutions, loaded by tank trucks, might be sensible for facilities with extremely high material turnover. This option is extremely expensive and should be planned early with the initial facility layout. Moreover it must be evaluated whether the supplier is prepared to conduct the loading by tank trucks.

### 4.4.2 Filling of water bottles

#### 4.4.2.1 Processing of drinking water

In order to slow the microbial contamination, water can be treated with additives like chlorine or acid. For further information, you can also refer to the GV-SOLAS brochure „Trinkwasser für Versuchstierhaltungen“, „Gelbes Heft“ (Drinking water for laboratory animal facilities, “yellow booklet”).

#### 4.4.2.2 Design of bottle fillers

For a convenient, user friendly workflow, unnecessary stacking and moving of items should be avoided. Hence, a bottle filling machine should be located in a way that the bottles can be refilled immediately after removal from the washer. It is important to keep an ergonomic working height of approximately 800 to 900 mm.

For a best possible workflow, the transport systems described in chapter 4.1 should be moved next to the bottle filler and locked there. Generally, avoiding major torso twists and long transport distances is not only ergonomically reasonable, but also timesaving. Therefore, filling stations can be designed and arranged „in a line“ as part of the entire bottle processing station.

**Size:** When determining the dimensions of a bottle filler, current and future capacities and requirements as well as the bottle crate capacity (e.g. 18 bottle crate) should be taken into consideration.

**Material:** Stainless steel (material AISI 304 or higher) offers a major advantage regarding durability and cleaning. If the drinking water is chlorinated or acidified with hydrochloric acid, extra caution is advised (please refer to chapter 9.5)!

**Cleaning:** A bottle filler should be easy to clean and be designed accordingly. A simple clean should be done daily, an intensive clean of the entire machine every week.

#### 4.4.2.3 Bottle filling systems – advantages / disadvantages

Below you will find options for a manual, semi-automatic, and fully automatic refilling of water bottles:

Table 4-7

	Option	Advantages	Disadvantages
Manual systems	single filling with hose and/or use of a manual filling manifold	cost-effective; can be introduced within an existing facility; flexible	time-consuming; low capacity; ergonomically very difficult
Semi-automatic systems	multiple filling with a fixed filling manifold, automatic identification and dispensing	relatively cost-effective; can be introduced within an existing facility; timesaving	medium capacity; not the most suitable ergonomic option
Fully automatic systems	fully automatic filling and refitting of caps by robots or automatic machines	timesaving; ergonomically beneficial; high capacity; reduced staff possible	high investment costs; possible limitations due to the need to standardise bottles; high maintenance; requires large space

## 4.5 Steam sterilisation

Steam sterilisation has proven its reliability as a universal sterilisation procedure in animal facilities.

### 4.5.1 Requirements for steam sterilisers

Sterilisers in animal facilities can be necessary for the following purposes (as described in chapter 2):

- to provide sterilised items into specific operational areas (“sterilise in”)
- to dispose of potentially infectious or genetically modified material from specific operation areas to the outside (“sterilise out”).

Please find below a description of different machine groups, processes, dimensions and technical components.

#### 4.5.1.1 Products and materials

For selecting and operating sterilisers in animal facilities, the following differences should be considered:

- heat-resistant / heat-sensitive,
- solids / liquids,
- with solids: porous / non porous.

Heat-resistant products in this case of application are materials that can be steam sterilised at 121 °C for at least 20 minutes. Heat-sensitive products do not tolerate this temperature (e.g. computers, microscopes, power tools).

For safety reasons, solid materials are treated differently from liquid ones (e.g. boiling delay with filled water bottles). Due to their surface structure porous products (e.g. feed bags, cages with bedding, textiles), require special procedures for air removal and steam penetration. In contrast non porous products possess a flat, closed surface structure (e.g. cages, racks, empty water bottles).

#### 4.5.1.2 Devices and procedures

Sterilisers should meet the requirements specified by the German Institute for Standardization in DIN 58951-1 (Sterilization – Steam sterilizers for laboratory items). This directive describes different machine groups. Sterilisers for animal facilities can be found in group D.

Depending on the type of products to be sterilised, sterilisers should permit combinations of process steps as described in the table below:



Table 4-8

Products	Pretreatment	Steam sterilisation	Aftertreatment
imporous	PVP / FVP	suitable combinations of temperature and time, e.g. 121 °C with a 20 min holding time	VWD
porous	FVP		VWD
liquid	PVP		SAC
waste/GMO	FVP		VWOD / VWD
animal carcass	FVP		PRAP / VWOD

PVP: prevacuum process

FVP: fractionated vacuum process (pulsing)

VWD: vacuum with drying time

VWOD: vacuum without drying time

SAC: steam/air mixture cooling (indirect cooling with back pressure)

PRAP: (slow) pressure relief to atmospheric pressure

Please pay attention to the following aspects:

- When sterilising items made of polycarbonate, alkaline residues on the items need to be avoided (otherwise the material, due to hydrolysis, will be destroyed; please refer to chapter 9.1).
- When sterilising feed or bedding in bags, needled plastic bags or a steam permeable bag material should be used.
- For the sterilization of animal feed the heat impact should be reduced to the minimum level necessary for sterility in order to prevent damage of thermolabile feed components (e.g. vitamins). Otherwise problems with breeding and maintenance of the animals can occur.
- With liquid products: Temperature measurement in a reference vessel should be performed (otherwise danger to life due to delayed boiling; removal temperature < 80 °C). Active cooling with back pressure is preferred.
- When sterilising filled polycarbonate water bottles, a low steam sterilisation temperature, e.g. 118 °C, is recommended in order to protect the material, with a longer dwell time, e.g. 40 min, if necessary. In case microbiological testing is wanted, inactivation of the microbes requires a much longer exposure time.
- When sterilising water bottles with caps on, bottles with a silicone sealing ring are mandatory in order to avoid leakage (different expansion coefficients of metal and plastic).
- Solids (and cage bases in particular) and porous loads (cage bases with bedding) should be as dry as possible when put into a steriliser (evaporative heat loss, drying time).
- Waste treatment: Chamber exhaust air and condensate are to be treated to inactivate or remove contamination risk (e.g. exhaust air filtration and condensate steam sterilisation). It is important to use packaging to ensure steam can penetrate all waste in the load.
- When sterilising carcasses, special programs are to be used, depending on the size of the animal. Please consult the machine manufacturer.
- When loading porous material (bedding, feed) hygroscopic condensation can cause local overheating.

### 4.5.1.3 Dimensions

Sterilisers can have different characteristics of design:

- chamber with floor level access / without floor level access
- one-door / two-door

The work space is usually indicated in decimetre measuring height x width x depth. Hence, a steriliser measuring 18x12x15 possesses a usable rectangular volume of at least 1800 mm (h) x 1200 mm (w) x 1500 mm (d). The actual internal chamber size is larger in all dimensions and should be adapted to the loading system accordingly.

The sizes usually preferred for sterilisers with floor level access in animal facilities are:

18x10x15 (clear chamber dimension: approx. 2000 x 1100 x 1600 mm)

18x12x15 (clear chamber dimension: approx. 2000 x 1300 x 1600 mm)

In addition to the usual preferred sizes, floor-level accessible sterilisers with a clear chamber height of up to 2200 mm and, if necessary, a correspondingly larger clear chamber depth are also required on a case-by-case basis. This is due both to new IVC racks with larger dimensions (especially height and depth) and to the fact that for ergonomic or hygienic reasons, for example, ventilation pipes on the racks are not dismantled before sterilization with existing IVC racks.

Depending on the structural conditions of the building, external dimensions of some machine parts must be adapted for the transport (into the building) and installation situation (please refer to chapter 5).

#### 4.5.1.4 Technical components

A detailed description of the general requirements of machine and safety engineering is provided in DIN 58951-2. Please refer to below some important examples.

##### **Airtight sealing of barrier areas**

A general description of the sealing design is provided in DIN 58951-2, Art. 7.7. In practice, the sealing should be mechanically fixed to the steam sterilisation chamber and be equally well connected to the side walls and floor. Especially with machines designed in a pit, it is important to seal the floor area beneath the chamber, as this area will not be accessible afterwards. The maximum permitted leakage equates to the requirements of air conditioning units in order to maintain defined pressure differences in the separate areas.

##### **Permissions**

With frequent changes in operating staff, it is recommended to protect the program start with passwords (staff password). In order to make adjustments at the machine or to run special programs (e.g. removal of a barrier) it is recommended to allocate further passwords or key switches to selected personnel only.

##### **Vacuum pump**

Operating vacuum pumps produce relatively high noise levels that can potentially reach the animal rooms. As many animals are very sensitive towards noise, it is recommended to set up the vacuum pumps in engineering rooms further away. If there is not enough space available for an external installation of vacuum pumps, sound-damping measures inside the steriliser should be taken.

##### **Central recording of malfunction notices**

The steriliser should be able to automatically forward process-relevant notices of malfunction to a central control room.

##### **Remote access and diagnosis**

In order to be able to carry out a quick diagnosis by the manufacturer in the event of faults or malfunctions in the plant, even without the presence of a qualified service technician on site, modern control systems should be used with the possibility of external remote access via the Internet. For this purpose, the necessary hardware and software preparations as well as the network and firewall settings must be coordinated at an early stage with the in-house IT department with the involvement of the manufacturer. In the case of new construction plans, it is advisable to specify this already in the planning phase.

##### **Feeding steam into the chamber**

Sterilising cages with bedding inside puts high demands on the steam supply. When feeding steam into a chamber, the steam must not be directed at the cages in order to avoid the bedding being blown around. For a gentle dispersion of steam, special attachments on the chamber wall are necessary. An accumulation of bedding on the chamber floor, however, cannot be fully avoided. Therefore, the floor should be easy to clean (sweep), which means it should also be free from attachments. Existing dirt traps and filters should be conveniently accessible and easy to clean. Also, evacuation openings must be equipped with a filter to prevent bedding material from being sucked in.

##### **Steam sterilisation chamber with floor level access**

The chamber floor should allow for a flexible use of loading trolleys with different track widths (no protruding attachments in the floor area).

##### **Flexible reference probe for sterilising filled water bottles**

A temperature probe should be well accessible from both sides. When running programs without using the reference probe, the probe and its cable should be mechanically attached to the chamber wall and thus be shielded. In some cases it can be necessary to protect the cable with an additional metal hose.

**Interlocking door mechanism**

In machines installed within an airtight barrier, it is necessary to define a specific direction in which items must always be sterilised. In the opposite direction, however, it is usually possible to transfer items through the steriliser without actually sterilising them. It is important to determine exactly in which direction the steam sterilisation is done (SPF area, quarantine area). Special cases might occur where it is necessary to sterilise items in both directions. The exact program or possible changes between these options must be specified in advance.

**Cycle documentation**

In order to document the steam sterilisation process, a continual record of the temperature and pressure profile is important. According to GLP, documentation is necessary for assigning a given item to a recorded cycle. A cycle document should always contain information on temperature and pressure, as well as on the date and time, the type of steam sterilisation program, cycle number, and release.

**Exhaust air filter / filter in the vacuum line**

Device for sterile filtration of evacuated air from the sterilisation chamber during the preliminary phase of a sterilisation cycle with infectious material.

Exhaust air filters are installed in the vacuum line between the chamber and the vacuum pump and should be sterilisable "in-line". In particular, sterilisation of the filter is required before disassembly and disposal.

In the statement of the project group "Laboratory Technology" of the Committee for Biological Agents (ABAS) on the topic "Installation recommendations for new installations, retrofitting or additions, for the choice of exhaust air treatment of autoclaves", installation recommendations are given for exhaust air filters in autoclaves in laboratory areas of bio safety levels BSL1 to BSL4.

**Condensate sterilisation**

Device for the safe retention and inactivation of the condensate accumulated during a sterilisation cycle with infectious material.

**4.5.2 Special requirements on process validation****4.5.2.1 Initial situation regarding standards:**

The process validation should be carried out according to EN ISO 17665. Ideally the extent of the process validation as well as the acceptance criteria should be defined in agreement with the operator.

Comment: The acceptance criterias are defined in the EN 285 for medical devices only and therefore are not applicable for applications in animal facilities.

**4.5.2.2 Operational qualification (tests with empty chamber):**

Testing of temperature distribution within the empty chamber.

Acceptance criteria:

Ideally the acceptance criteria should be defined in agreement with the operator.

Recommendations for testing:

- Each 1 x test with empty chamber per sterilization program (e.g. 134 °C, 118 °C), each with thermometric measurement
- Reproducible measurements (3 x) without load are normally not necessary in animal facilities.
- Thermocouples / Thermologgers have to be positioned on the empty loading cart / loading tray.

**4.5.2.3 Performance qualification (tests with load):**

Testing of temperature distribution within the loaded chamber (tests with load). The load configurations to be tested should be defined by the operator/customer.

Acceptance criteria:

The acceptance criteria should be defined in agreement with the operator. For the definition of criterias product specific parameters (e.g. prevention of overheating for animal feed) have to be considered.

Recommendations for testing:

- Reproducible measurements (3 x) with load for each / defined sterilization program, each with thermometric measurement and microbiological testing if applicable.
- If the above is not possible Thermocouples / Thermologgers have to be positioned within the load and on the loading cart / loading tray.

#### 4.5.2.4 Sterilizing goods which require special attention:

Animal feed / bedding:

Special attention is required for feed and bedding (package size, abrasion, thermally induced agglomeration, overheating). For animal feed, overheating can damage ingredients (e.g. vitamins). Such overheating should not be much higher than 3 K. In case of hygroscopic condensation the above mentioned threshold value for the temperature band can be exceeded significantly. This overheating resulting from hygroscopic condensation is not a malfunction of the sterilizer, but it is a physically based after effect for porous loads. In such cases the further procedure needs to be in agreement with the operator.

Bedding in cages:

Problem of excessive humidity: Depending on the pre-treatment and / -stacking of cages steam access is possible but the resulting condensate cannot be removed. The wet bedding is clumped and could be non-sterile.

#### 4.5.2.5 Recommendations for test cycles:

- The AK KAB recommends a cyclic re-qualification annually and an absolute minimum standard of every 2 years.
- Recommendations for acceptance criterias can be requested by the manufacturer.

## 4.6 Reduction of microorganisms on heat-sensitive products by means of hydrogen peroxide (H<sub>2</sub>O<sub>2</sub>) / peracetic acid (PAA)

In cage processing transferring non-steam-sterilisable, heat-sensitive products in and out of a barrier area is of crucial interest. This procedure is usually done by means of H<sub>2</sub>O<sub>2</sub> / PAA (peracetic acid) and is generally known as sanitization which aims to inactivate pathogenic micro-organisms. Other than with thermal steam sterilisation the local effect of the sanitization procedure is only verifiable by means of indicators and cannot be captured directly by process parameters like temperature or pressure. The sole process of room gassing will not be discussed in this context.

### 4.6.1 Material lock

There are two relevant procedures for heat-sensitive products to cross a barrier via so-called locks: One is by being gassed with hydrogen peroxide (H<sub>2</sub>O<sub>2</sub>), the other is by being sprayed with peracetic acid (PAA). Special cases like transferring items out of BLS3/BLS4 areas will not be part of the general discussion here, as these cases always need to be examined individually. Below you will find characteristic examples of heat-sensitive products for the two presented sanitization procedures:

- characteristic heat-sensitive products suited to both procedures: e.g. vacuum-packed, gamma-irradiated large or small feed or bedding bags,
- characteristic heat-sensitive products for H<sub>2</sub>O<sub>2</sub> use only: e.g. power tools, computers, microscopes, measuring devices, fan units, cage changing stations, microbiological safety work benches, ventilated animal housing cabinets, bedding disposal stations,
- characteristic heat-sensitive products for PAA use only: simple, corrosion-resistant tools, other products with a solid PAA-resistant surface,
- transport containers to bring animals into a barrier area.

**Please note:**

Due to a material-related heavy absorption, gassing plastic cages with H<sub>2</sub>O<sub>2</sub> can cause problems with the slow release of the gas. The GV-SOLAS thus recommends to refrain from gassing plastic cages in order to prevent animals from the risk of increased H<sub>2</sub>O<sub>2</sub> exposure.

## 4.6.2 Requirements of processing procedures by means of H<sub>2</sub>O<sub>2</sub>

Below you will find a description of effect and suitability of vaporised H<sub>2</sub>O<sub>2</sub> for reducing organisms in locks as well as its limitations of use that need to be examined more closely.

### Sanitization with H<sub>2</sub>O<sub>2</sub>

H<sub>2</sub>O<sub>2</sub> is a strong oxidant with efficient inactivating abilities for microorganisms like spores, bacteria, viruses, and fungi. In liquid and vaporised state, H<sub>2</sub>O<sub>2</sub> is colourless and odourless. For information on safe handling of H<sub>2</sub>O<sub>2</sub> in liquid and vaporised state, please refer to the data sheets on occupational safety (please note the safety data sheets of the manufacturers). Over time H<sub>2</sub>O<sub>2</sub> in liquid state can become increasingly concentrated due to the evaporation of the H<sub>2</sub>O. It can therefore easily cause chemical burns (skin contact) and material damage (corrosion). Materials like pulp, textiles, or bedding (wood) are highly prone to absorbing H<sub>2</sub>O<sub>2</sub>. Due to chemical reactions, the flashpoint of these materials is lowered. Therefore, these products should not be treated with H<sub>2</sub>O<sub>2</sub>.

Gassing with H<sub>2</sub>O<sub>2</sub> offers a major advantage to Chlorine Dioxide or Formaldehyde as it produces no visible or toxic residues. Due to its instability (thermally induced decomposition, light-induced decomposition, catalytic decomposition), it splits back into H<sub>2</sub>O and O<sub>2</sub> after the gassing procedure is finished. Furthermore, a gassing with H<sub>2</sub>O<sub>2</sub> can be done at room temperature and atmospheric pressure. Thus, no extra pressure container is needed and the items to be gassed are not exposed to a critical temperature and pressure level.

Currently, the common maximum allowable concentration (MAC) is MAC<sub>H<sub>2</sub>O<sub>2</sub></sub> = 1.0 ppm. Under discussion is a value of 0.5 ppm. (Please consult the laws and regulations of your respective country/EU standards.)

### Limitations of use that need to be examined closely

Besides the stated lowering of the flash point, time is always a crucial factor in considering its use due to the slow release of the H<sub>2</sub>O<sub>2</sub> from the materials mentioned above. Absorption is not the only principal limitation to be considered here. There are also materials like nylon, rubber, or natural rubber (e.g. flooring) that suffer damages from H<sub>2</sub>O<sub>2</sub> gassing. It needs to be clarified individually if a material is resistant to H<sub>2</sub>O<sub>2</sub>. The surface of the items to be gassed must be clean, dry, and non porous. Gassing heavily soiled and porous surfaces should be avoided.

### 4.6.2.1 Basic lock types for H<sub>2</sub>O<sub>2</sub> gassing

For gassing items with H<sub>2</sub>O<sub>2</sub> the following basic options are possible:

- large, walk-in locks (gastight room or stainless steel chamber), common usable dimension: 2000 mm x 1000 mm x 2000 mm (hxwxh),  
In addition to the usual preferred sizes, higher chamber dimensions of up to 2200 mm are required on a case-by-case basis. This is due both to new IVC racks with larger dimensions (especially height) and to the fact that, for ergonomic or hygienic reasons, existing IVC racks do not, for example, have ventilation and deaeration tubes dismantled on them prior to H<sub>2</sub>O<sub>2</sub> gassing,
- small pass-through locks, common usable dimension: 560 mm x 560 mm x 760 mm (hxwxh),
- sterilisers or suitable rack washers that function as locks.

When using sterilisers and rack washers for H<sub>2</sub>O<sub>2</sub> locks, the additionally required process time needs to be considered when calculating capacity and design of these machines. For all three options the H<sub>2</sub>O<sub>2</sub> generator can either be installed permanently or designed as an external, mobile unit that can be docked to the lock.

### 4.6.2.2 Constructional requirements

Constructional requirements include the mechanical structure, procedural components, and electrical structure of H<sub>2</sub>O<sub>2</sub> locks.

#### 4.6.2.2.1 Mechanical structure

The mechanical structure of an H<sub>2</sub>O<sub>2</sub> lock must meet the following requirements:

- Lock chambers must be designed of stainless steel.
- With room locks, the material resistance and surface finish of walls and floors must be verified (H<sub>2</sub>O<sub>2</sub>-resistant epoxy resin).

- Gastight doors with a suitable gasket system can be made of safety glass or stainless steel with an inspection window.
- Airtight connection between lock and building.
- Gauge port or measuring line for leakage test.
- A sampling port for determining the  $H_2O_2$  concentration is to be considered for installation inside the chamber or inside the gas return pipe.

#### 4.6.2.2.2 Procedural components

The following procedural components should be considered for  $H_2O_2$  locks:

- HEPA filter for supply air and exhaust air (either inside the lock or on-site).
- Air circulation system for gas distribution (in small chambers via the generator, in big chambers via a rotation system or pivoting fans inside the lock).
- Automatic valves or shut-off dampers with repeater.
- Exhaust air containing  $H_2O_2$  must only be discharged through the roof via separate exhaust air pipes.
- Before being discharged, the exhaust air containing  $H_2O_2$  can be circulated through a catalyser in order to reduce the  $H_2O_2$  concentration inside the discharge air pipe or, where applicable, to avoid the extra pipe completely.
- Gastight shut-off dampers (in supply air and discharge air pipe).
- The pipe works for the lock (internally) as well as for the generator connection should be made of stainless steel or plastics (e.g. PP, PVC-U). To ensure a universal use, the generator can be equipped with camlock couplings (the dimensioning of the connection should be discussed with the manufacturer of the generator).
- Galvanised sheet steel and copper pipes (catalytically effective) require special precautions in order to prevent material damage and to ensure process effectiveness.

#### 4.6.2.2.3 Electrical structure

The electrical structure of  $H_2O_2$  locks must meet the following requirements:

- Control and communication (control via PLC or microprocessor controller, release, signal exchange, start/stop/abort signal, end of gassing, time control via validation) with the  $H_2O_2$  generator must be provided.
- An operation display (indicating “process running”, door release, warning light) at the loading and unloading side is required.
- Door control (gasket control via sealing pressure, “door closed” contact) and locking must be monitored during the gassing cycle.
- The feedback signal of the valves must be monitored.
- An electrical connection for the generator and an optional socket inside the chamber must be provided.
- Emergency stop buttons must be applied to each side and safety measures (emergency release of doors) taken inside walk-in chambers.

#### 4.6.2.3 Processual requirements

Please pay attention to the following aspects on process requirements:

##### Leakage test

Before starting the gassing cycle, it is recommended that the lock undergo a leakage test. This test can be performed with the  $H_2O_2$  generator.

##### Safety monitoring / ambient monitoring

$H_2O_2$  is a mildly odorous gas heavier than air. Thus a monitoring probe with automatic notice of malfunction is best placed 0.5 – 1.5 m above ground. The probe should be shielded from mechanical damage.

##### $H_2O_2$ gassing cycle

Figure 4-11 shows a characteristic textbook  $H_2O_2$  gassing cycle. After **dehumidifying** and **conditioning** the lock, a vaporised  $H_2O_2$  air mixture is fed in (gassing) until a required degree of concentration is achieved. What follows is the **dwel phase** where the  $H_2O_2$  concentration is kept on a more or less constant level. In the final step (**ventilation**) the lock is ventilated or the  $H_2O_2$  discharged with the exhaust air, which finishes the gassing cycle.

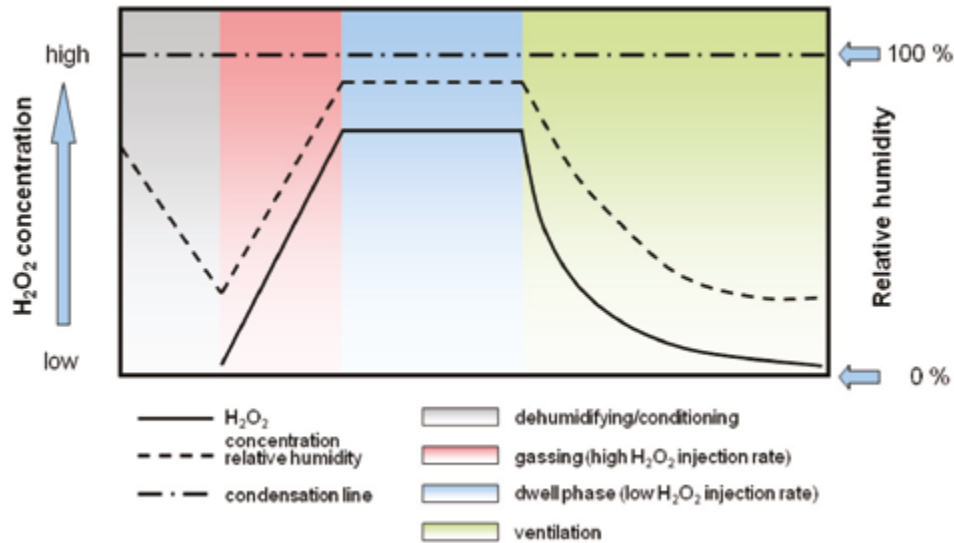

Figure 4-18: Characteristic text book process scheme of a H<sub>2</sub>O<sub>2</sub> gassing cycle

Please note, however, in table 4-18 that evidence of the effectiveness of sanitization is only provided by biological indicators. Currently, changes in H<sub>2</sub>O<sub>2</sub> concentration (concentration curve) cannot be acquired by measurement techniques sufficiently accurate for operator demands.

With each gassing and dwell phase, the lock is given a defined H<sub>2</sub>O<sub>2</sub> injection. Based on this injection rate, the effective H<sub>2</sub>O<sub>2</sub> concentration during the dwell phase, other than shown in the textbook cycle, does not necessarily have to be constant. A rising or falling of the H<sub>2</sub>O<sub>2</sub> concentration level is more likely. Prolonging the dwell time without revalidating the cycle, however, can cause problems, as a potential H<sub>2</sub>O<sub>2</sub> oversaturation might lead to a condensation of H<sub>2</sub>O<sub>2</sub>.

Loading volume and configuration can influence the required H<sub>2</sub>O<sub>2</sub> injection rate, gas distribution, and ventilation. With H<sub>2</sub>O<sub>2</sub> absorbing materials, like plastics, a longer ventilation time might be necessary. Different loading configurations can thus require individual program cycles. The effectiveness of them should always be verified and each process should ideally be validated. When planning the machines, this needs to be taken into account.

### Cycle development

The process parameters of a cycle should be adjusted to each lock and its load. The cycle development must be discussed with the manufacturer of the generator. In order to avoid material damage, clearly visible condensation must be averted. Please find below information on applications (e.g. electronic devices) and cycle-relevant parameters:

- Humidity exceeding the saturation level must be avoided (verifiable with mirror / pane test). Room capacity, initial temperature and humidity must be considered.
- The H<sub>2</sub>O<sub>2</sub> injection rate must be adjusted to the absorption rate of the chamber surface and load.
- Surface temperature and volume of the items to be gassed influence the maximum allowable, condensation-free H<sub>2</sub>O<sub>2</sub> concentration (too cold surfaces bear a higher condensation risk).
- The warm H<sub>2</sub>O<sub>2</sub> air mixture should be streamed into free space (e.g. from above) in order to avoid direct contact with cold surfaces (e. g. walls and doors) resulting in condensation.
- Computers and other electronic devices should be cleaned in advance (dust should be removed) and stay switched on while being gassed (PC ventilators, fan units, etc. must be on).
- Heavy condensation leads to increased H<sub>2</sub>O<sub>2</sub> consumption, differences in concentration distribution, increased risk of material damage, and a longer ventilation time.
- Pre-heating long supply pipes can help avoid heavy condensation.

### Proof of efficacy / validation

The distribution of H<sub>2</sub>O<sub>2</sub> concentration is tested with a colour change of chemical indicators. A visual verification through an inspection window can be made while the process is running.

The microbiological efficacy is verified by use of biological indicators, usually H<sub>2</sub>O<sub>2</sub> gassing-suited spore strips (*Geobacillus stearothermophilus*) holding a population of 10<sup>5</sup> to 10<sup>6</sup>. When agreed upon with the operator,

other organisms (e.g. *Bacillus subtilis*, *Enterococcus faecium*) can be used for verification, too. At least six of these biological indicators per m<sup>3</sup> spatial volume must be placed at crucial points inside the lock. Add diagram as example of 'crucial points / positions' of biological indicators?

#### 4.6.2.4 Processual documentation

The H<sub>2</sub>O<sub>2</sub> generator should automatically compile a cycle record. According to GLP, documenting is necessary for assigning a given item in the processing procedure to a recorded cycle. The cycle record should contain information on temperature, relative humidity, air flow, operator, date, time, injection time and rate, ventilation time, total consumption of H<sub>2</sub>O<sub>2</sub> per cycle phase, time sequence, selected gassing program, notices of malfunction, and release.

#### 4.6.3 Requirements of processing procedures by means of peracetic acid

Procedures using peracetic acid (PAA) have become less important and are often replaced by H<sub>2</sub>O<sub>2</sub> procedures. Below you will find essential information on the effectiveness and suitability as well as limitation of PAA for sanitization in locks.

##### Sanitization with peracetic acid

Sanitization with PAA is a wet procedure that is only suited for items with a non porous surface. PAA is a highly effective disinfectant with highly oxidising characteristics. For a safe handling of PAA, please consult the respective work safety data sheets (please pay attention to the safety data sheets of the manufacturer). A low concentration of PAA (0.5 – 1.5 %) inactivates spores, bacteria, viruses, and fungi at a low temperature of 4 to 20 °C.

PAA in diluted solution consists of a balance of H<sub>2</sub>O<sub>2</sub> and acetic acid. Therefore, the limit levels of H<sub>2</sub>O<sub>2</sub> (1 ppm) and acetic acid (10 ppm) are of crucial interest. When there is no noticeable acetic acid odour, it is safe to say that the air value limits are within normal range. If the ventilation is insufficient, however, visible residues can occur.

##### Safety note:

PAA has a severe skin and eye irritating effect on humans and animals. This needs to be considered, especially when introducing animals into a barrier area by means of PAA process (**only in airtight taped transport containers!**).

##### Limitations of use that need to be examined closely

Whether or not a material is resistant to PAA must be examined on a case-by-case basis. The sealing materials thereby demand particular attention. Natural rubber, rubber, soft PVC, aluminium, iron/steel, brass, and copper for example are not suitable.

#### 4.6.3.1 Constructional requirements

Constructional requirements include the mechanical structure, procedural components, and electrical design of PAA locks. In animal facilities PAA locks are usually designed as pass-through locks. The common usable dimension is 560 mm x 560 mm x 760 mm (hwxwd).

##### 4.6.3.1.1 Mechanical structure

The mechanical structure of PAA locks must meet the following requirements:

- Lock and pipes must be designed in a hygienic way in stainless steel (dead spots and wet spots are to be avoided).
- The internal part of the lock must be equipped with a coarse meshed, removable dish rack.
- Spray heads for a fine atomising and homogenous distribution of PAA are recommended.
- Two safety glass doors sealed and interlocked should be built in.
- Gastight floor drain.
- Airtight connection of the lock to the barrier line of the building.
- Connection port for feeding the PAA pipe, complete with shut-off valve.
- Storage rooms for storing PAA must be equipped with forced ventilation and bund tank.



#### 4.6.3.1.2 Procedural components

PAA locks require the following procedural components:

- PAA may neither be locked in pipes between valves nor be used in closed machines. Container and pipes alike must be equipped with ventilation devices. Intrusion of contaminants must be prevented.
- HEPA filter for supply and exhaust air (either inside the lock or on-site)
- Gastight and PAA-resistant shut-off valves (ventilation) are required.
- Compressed air for atomising PAA must be provided.
- PAA must not be fed into regular drains. Suitable collection tanks with separate ventilation must be provided (drains must be gastight and lockable with a valve).
- Exhaust air must be discharged through a separate pipe (50 to 100 air changes for aeration / drying are required).

#### 4.6.3.1.3 Electrical structure

The electrical structure of PAA locks must meet the following requirements:

- Control and communication (control via PLC or microprocessor controller, release, signal exchange, start/stop/abort signal, end of cycle, time control via validation) must be provided.
- An operation display (indicating “process running”, door release, warning light) at the loading and unloading side is required.
- Door control (gasket control via sealing pressure, “door closed” contact) and locking must be monitored during the cycle.
- The feedback signal of the valves must be monitored.
- The filling level of the supply and collection tank must be monitored.
- Emergency stop buttons must be applied to each side.

#### 4.6.3.2 Processual requirements

PAA locks must meet the following process requirements:

- Visual assessment of the spray distribution must be provided.
- Cycle development: spraying time, amount of PAA, ventilation time must be displayed.
- Loading volume and configuration: puddles on the load are to be avoided.
- Effectiveness should be proven by means of biological indicators.

#### 4.6.3.3 Processual documentation

The controller must automatically compile a cycle record. According to GLP, documenting is necessary for assigning a given item in the processing procedure to a recorded cycle. The cycle record should contain information on temperature, operator, date, time, PAA consumption, ventilation time, selected spraying program, notices of malfunction, and release.

## 5 Requirements of facility construction

For the correct functioning of all cage processing equipment, professional construction planning, preparation (please also see chapter 6.1) and the correct specification of the utility supply and disposal system is essential.

### 5.1 Distribution of responsibilities

When procuring machines for cage processing, please note that the connection of the systems to on site installations (supply air / discharge air / superheated steam / water / compressed air / electrical supply line) is the responsibility of the respective companies carrying out the construction work. Shut-off fittings are services provided by the customer.

The manufacturer must receive from the customer / operator all necessary documents for preparing a layout drawing.

For the overall process of providing / acquiring machines for cage processing – this includes shipping, assembly, and warranty – please consult the laws and regulations of your respective country/EU standards.

## 5.2 Requirements of utilities and utility systems

The manufacturer must inform the customer / operators in time about the type, quality, and quantity of utilities that must be provided by the customer as well as about measures that must be taken on site in order to set up, connect, and operate the processing machines.

The manufacturer-stated requirements regarding quality and quantity of utilities, including supply and discharge systems, must be respected by the customer. If not, it can be expected that the machine will not operate correctly. The result might be a poor performance in washing, rinsing, and drying, insufficient steam sterilisation, extended cycle times, and damages of the items to be processed as well as the machines.

Please note the following aspects regarding media and interfaces:

### 5.2.1 Water, softened water, and demineralised water

Water first of all means drinking water. When used for cage processing, water must meet the following required limits. In some cases it needs to be processed first, e.g. by softening, demineralisation.

#### *Softened water*

Appearance:	colourless, clear
Total hardness to	3° d or 0.5 mmol/l
pH Value	5–9
Evaporation residue	< 500 mg/l
Chlorines	< 100 mg/l

To avoid spots on the items for processing caused by dissolved salts deposits from the softened water the AK KAB recommends to use demineralised water as a minimum standard for the last rinse.

#### *Demineralised water (=Demi water)*

Demineralised water is processed water that can also be used for feeding clean steam generators (according to EN285):

Appearance:	colourless, clear, without deposits
Electric conductivity(at 25°C)	< 5 µS/cm
Total hardness	≤ 0,1° d resp. ≤ 0,02 mmol/l
pH Value	5 - 7.5
Evaporation residue	≤ 10 mg/l
Chlorines	≤ 1 mg/l
Phosphates (P <sub>2</sub> O <sub>2</sub> )	≤ 0,05 mg/l
Silicates as SiO <sub>2</sub>	≤ 1 mg/l
Iron	≤ 0.2 mg/l
Lead	≤ 0.05 mg/l
Cadmium	≤ 0.005 mg/l
Residues of heavy metals (except iron, cadmium, lead)	≤ 0.01 mg/l

#### **Please note:**

For a best possible automatic processing, it is recommended to use Demi water (in order to avoid corrosion and staining; please refer to chapter 9). In contrary to above mentioned data experience shows that Demi water with an electric conductivity of approx. 15 µS/cm is tolerable. The material compatibility of the pipework is also an important consideration.

For guidelines regarding the installation of water connections, please consult the laws and regulations of your respective country/EU standards.

Before the machines can be shipped and set up, the manufacturer must provide the customer with the following construction relevant information on water supply:

- minimum / maximum dynamic pressure at the interconnection of machine and building installations
- connection dimension
- maximum capacity (peak value)
- maximum consumption per hour
- water quality / hardness
- water temperature

## 5.2.2 Steam

The customer is required to drain the steam pipes and equip them with a filter placed directly before the machine. Horizontal pipes must be passed toward the consumption point with an incline of 1:50. The steam pipes must be insulated against heat loss. (Please refer to ordinances on heat insulation as defined by your respective country/EU standards.)

### 5.2.2.1 Heating steam

Steam quality required for heating washers:

Table 5-1

Parameter	Units	Max values
steam dryness	kg steam/kg (steam + water)	> 0.95
total hardness	mmol/l	≤ 0.02
pH value	pH	5 - 9
conductivity (at 20 °C)	μS/cm	≤ 10
Appearance		colourless, clear
chlorines (Cl <sup>-</sup> )	mg/l	-
Iron	mg/l	≤ 0.1
Cadmium	mg/l	-
Lead	mg/l	-
heavy metal residues (except iron, cadmium, and lead)	mg/l	-
silicate as SiO <sub>2</sub>	mg/l	≤ 15
phosphates (P <sub>2</sub> O <sub>5</sub> )	mg/l	-
dirt particle	size in μm	≤ 300

### 5.2.2.2 Clean steam

Clean steam describes the quality of the steam that comes in direct contact with the items to be processed (please also see steam specification according to EN 285). The following information applies especially for steam sterilisation and steam drying in washers:

Table 5-2

Parameter	Units	Max values
pressure for steam sterilisation	bar	2.4 – 2.8
steam dryness	kg steam/kg (steam + water)	> 0.95
total hardness	mmol/l	≤ 0.02
pH value	pH	5 – 7
conductivity (bei 20 °C)	μS/cm	≤ 3
appearance		colourless, clear, without scaling
chlorines	mg/l	≤ 0.1
iron	mg/l	≤ 0.1
cadmium	mg/l	≤ 0.005
lead	mg/l	≤ 0.05

heavy metal residues (except iron, cadmium, and lead)	mg/l	≤ 0.1
silicate as SiO <sub>2</sub>	mg/l	≤ 0.1
phosphates (P <sub>2</sub> O <sub>5</sub> )	mg/l	≤ 0.1
non-condensable gases	ml/l	≤ 35

**Please note:**

By filtering the heating steam, a steam quality can be achieved similar to the required quality of clean steam, which might be sufficient for a given case of operation. This, however, should be verified for each case individually (please also refer to “Leitfaden für die Praxis: Dampfversorgung für die Sterilisation von Medizinprodukten”, Herausgeber AK-Steri-Dampf – Practical guide: Steam supply for sterilising medical items, issued by AK-Steri-Dampf).

### 5.2.2.3 Requirements of heating steam and clean steam

The manufacturer must provide the customer with the following information:

- minimum / maximum dynamic pressure at the interconnection of machine and building installations
- connection dimensions (e.g. DN 20 PN 16)
- maximum capacity (peak value)
- maximum consumption per hour
- steam quality (please refer to above)

Depending on the above-mentioned necessary steam quality, the operator should opt for special materials (preferably stainless steel) when installing the steam pipes. The machine manufacturer must then be informed about which material was used for the pipework.

Quick changes in maximum and minimum steam demand inside the steriliser require a very quick working pressure regulating station in order to keep the necessary steam pressure at a constant level. The use of high-speed steam generators, however, cannot be recommended.

### 5.2.3 Condensate

When operating a machine with steam, it produces condensate that can be fed back. The customer must be informed about the occurring amount of condensate and the required pipe dimension.

### 5.2.4 Compressed air

Compressed air (industrial grade – filtered and oil-free) is used for pneumatic work and control procedures as well as for steam sterilization of filled water bottles, in order to create the required supporting pressure within the autoclave chamber. The compressed air must be available at the interconnection with a dynamic pressure of 6 to 8 bar.

Quality of compressed air used for pneumatic control procedures:

Maximum size of dirt particles	40 µm, according to ISO 8573-1 grade 5
Dew point	+3 °C, according to ISO 8573-1 grade 4
Maximum oil content	0.1 mg/m <sup>3</sup> , according to ISO 8573-1 grade 2

Quality of compressed air used for pneumatic decapping of water bottles (process air):

Maximum size of dirt particles	1 µm, according to ISO 8573-1 grade 2
Dew point	+3 °C, according to ISO 8573-1 grade 4
Maximum oil content	0.01 mg/m <sup>3</sup> , according to ISO 8573-1 grade 1

The manufacturer needs to inform the customer about:

- connection dimension
- maximum capacity (peak value)
- maximum consumption per hour

### 5.2.5 Electricity

Please pay attention to the conditions of connection according to DIN EN VDE 0100. On the part of the customer / operator the following mains connection must be provided:

Nominal voltage	3 x 400 V	(3ph/N/E)
Nominal frequency	50 Hz	

(The manufacturer must be informed of any variations of these values.)

The customer must also provide for a lockable main switch inside the power supply line of each machine.

The manufacturer must inform the customer about:

- connected load (maximum power input),
- protection rating
- consumption per hour (maximum consumption).

### 5.2.6 Network connection for remote access and diagnostics

For setting up remote access and diagnostics, an on-site network connection for connecting the machine control must be provided directly in the area of the units.

### 5.2.7 Wastewater

DIN 1986 (drainage systems on private ground) in principle applies here. If special local wastewater regulations are to be considered, the customer must notify the manufacturer. The manufacturer on his/her part must inform the customer about the required connection dimensions and amount of wastewater to be expected. The drain pipes must be acid-resistant.

### 5.2.8 Process exhaust air

The chambers / tunnels of a washer must be vented with a fan on the machine or a building exhaust fan. The extracted air must then be discharged to atmosphere through separate pipes provided by the customer. The extracted air contains steam / vapours that can also be mixed with detergent residues. The pipes must therefore be watertight, temperature and acid resistant. A suitable discharge of condensate must also be ensured.

For reasons of odour, exhaust air of the steam sterilisation process (coming from the vacuum pumps) should be discharged to atmosphere through a second, separate pipe. The same is recommended for exhaust air of H<sub>2</sub>O<sub>2</sub> / PAA locks. The type of air discharge opening as well as its proximity to surrounding buildings must be well considered in order to avoid a recirculation through air conditioning intake vents or open windows, also when weather conditions are unfavourable.

The manufacturer must provide the customer with information on:

- volume flow in m<sup>3</sup>/h,
- exhaust air temperature,
- exhaust air humidity,
- connection dimensions.

When pipes suffer high pressure loss, the customer should consider installing an additional fan at the end of each affected pipe.

The different amounts of exhaust air (general exhaust air coming from the processing centre, exhaust air coming from machines or from handling bedding) must be taken into account in order to maintain the desired relative room air pressure.

Note: Special care in the choice of the material of building exhaust air duct which have contact with H<sub>2</sub>O<sub>2</sub> is essential.

### 5.2.9 Heat dissipation

Heat emitted by the machines must be dissipated. If the heat is dissipated by extraction of air, fresh air must be fed back in in order to avoid overheating (> 50 °C) in the service room. When designing the capacity of the ventilation system, not only the heat of the machines is to be considered, but also the heat coming from the items being processed.

The manufacturer must provide the operator with information on:

- heat emitted by the machines (eg. in kW).

## 5.3 Construction dimensions, load-carrying capacity, and pit

The manufacturer must provide information on the installation dimensions, weight and operational weight of each processing machine so that room dimensions, structural load of the slab and ceiling can be calculated. This also applies for the minimum dimensions and loads of the transport route (façade opening, halls leading to the installation site, etc.). A potential replacement of machines at a later time, after the building is finished, must also be taken into account.

It is recommended for the operator to equip machines with floor level access with a watertight pit. The edges of the pit must be sealed with non-rusting reinforcements. The pit must be designed according to manufacturer instructions with a pit drain and odour trap. A common pit depth ranges up to 250 mm.

The manufacturer must provide the customer with information on:

- required pit dimensions, including position of drain.

## 5.4 Maintenance access and service room

For maintenance work inside the machine, the access for engineers and maintenance personnel specified by the manufacturer must not be obstructed by additional installations (e.g. ventilation ducts, pipeworks, cable trays). In walk-in service rooms, a light and socket with protection category IP54 must be installed.

## 5.5 Dispensing station for process chemicals

Process chemicals can be dispensed centrally or locally. When selecting a local dispensing system, the trading units should be placed next to the washer or in the service room. For deliveries of large containers, the access doors should be of sufficient size (barrel and pallet dimensions must be considered).

The advantage of central dispensing stations is that they can provide different washers with process chemicals from one large trading unit. Usually, dispensing stations are situated in a separate room that should be well accessible for deliveries of large trading units. Different dispensing systems may require specific construction requirements, this means the customer needs to consider the type of dispensing system when the facility or building extension is still in planning stage. The supplier of process chemicals should be involved in the planning early on.

Dosing with central dispensing stations can be conducted either by direct connection with the washer (figure 5-1) or through usage of a buffer / day tank (figure 5-2).

When storing process chemicals, legal restrictions and requirements (according to the federal water act of your respective country) must be followed. It is also necessary for the operator to meet the regulations specified in the respective safety data sheets. Collection tanks, eye wash stations, etc. must follow these regulations.

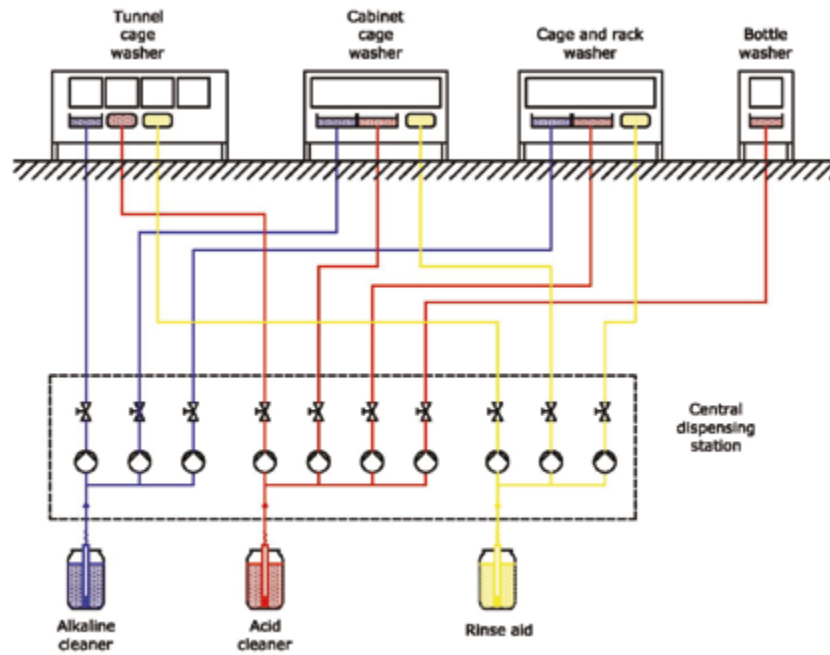

Figure 5-1 Example of a dispensing station without buffer / day tank

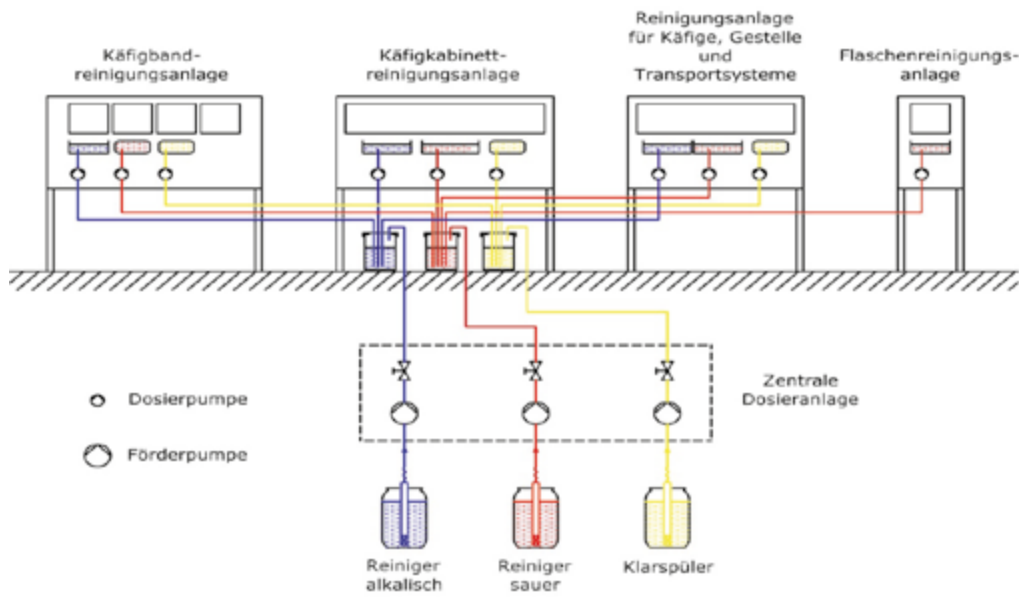

Figure 5-2 Example of a dispensing station with buffer / day tank

## 5.6 Installation data and consumption data

It is necessary in order to prepare for construction to know about installation and consumption data of the processing machines. This information must be provided by the machine manufacturer. The following table might be a helpful guide:

Table 5-3

Abbreviation	Description	Nominal size	Pressure	Temperature	Connection <sup>1</sup>	Consumption
HS	heating steam	DN	bar		kg/h	kg/h
CS	clean steam	DN	bar		kg/h	kg/h
CO	condensate	DN	bar	°C	kg/h	
CW	cold water	DN	bar		m <sup>3</sup> /h	m <sup>3</sup> /h
HW	hot water	DN	bar	°C	m <sup>3</sup> /h	m <sup>3</sup> /h
DW	Demi water	DN	bar		m <sup>3</sup> /h	m <sup>3</sup> /h
CA	compressed air, oil-free	DN	bar		Nm <sup>3</sup> /h	Nm <sup>3</sup> /h
WW	Waste water	DN		°C	l/min	
FD	floor drain	DN				
EAC	exhaust air chamber / tunnel	DN	Pa	°C	m <sup>3</sup> /h	
HD	heat dissipation				kW	kWh
EC	electrical connection 3ph / N / E 400 V AC 50 Hz				kW	
		protection rating			A	

<sup>1</sup>Instead of connection, maximum capacity or peak load could also be put in here.

## 6 Operation and Use

After describing technical specifications and requirements in the previous chapters, important aspects for the successful operation of processing machines shall now be discussed.

### 6.1 Influence of planning on operation

The successful commissioning of an animal facility will depend on the planning of the machine and the operational concept. The planning is very complex and very much subject to individual conditions and circumstances. Although this brochure cannot fully cover all aspects of a complete planning, some important considerations shall be described below.

Washers for animal facilities are generally set up in the processing centre. For an efficient operation, the machines must be well arranged to each other and according to the room dimensions. This should ensure a smooth flow of material (please refer to chapter 2).

The following aspects must be part of a cohesive planning process early on.



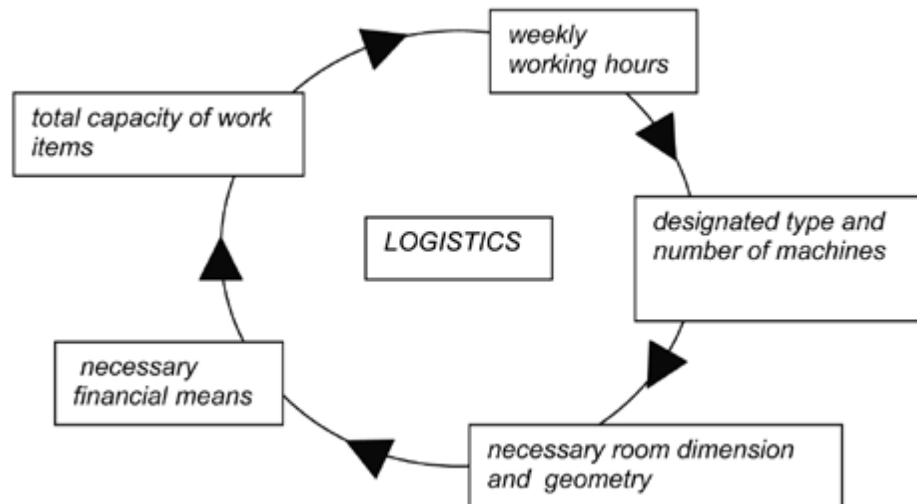

Figure 6-1 cohesive planning process

It is first of all essential for dimensioning the machines to determine the definite capacity of the different items to be processed (please refer to chapter 3) in the animal facility. For this purpose, it is necessary to know not only the number of items (e.g. cage bases, wire lids, water bottles, trolleys, etc.), but also the washing interval (calculation of capacity!). This data as well as the weekly working hours will define potential machine concepts (type and number of machines) and with that the deployment (not further discussed here) as well as spatial and financial requirements. Ergonomic aspects (conveying velocity, working heights, “arm length”, weights, etc.) and well approved loading models must also be considered.

When planning in detail, the following aspects must also be taken into account:

- downtimes and response times
- redundancies
- areas inside the processing centre to use as storage room / buffer / short term storage
- areas for process chemicals and dispensing stations
- accessibility for service work
- replacement option / façade opening for big, non-demountable machine parts
- occupational safety regulations / occupational safety measures
- cleaning and disinfection of the wash-up area and the machines placed therein

The processing centres are usually highly engineered, but also physically demanding for the operating staff (cleaning work, handling of faeces and urine soiled materials, odour and noise exposure, etc.). The quality of workmanship is highly significant for the operation of an animal facility. It is therefore required that the machines be easy to operate with the correct technical components to allow full proof operations.

Operator safety is also an important aspect to be considered:

- catching body parts in moving machine parts
- temperature of items when unloading the machines
- peripheral temperature of washers
- chemical fumes
- temperature of the workplace
- relative air humidity of the workplace
- sound pressure level of the workplace
- working heights of the different machines (800 and 900 mm)
- exposure to dust and allergens

## 6.2 Start up of operation

It is part of the manufacturer’s responsibility to first commission the machines into operation or to name an expert who does so in his place. Thereby, all operation, control, and safety devices must be checked for function and correct adjustment.

### 6.3 Handover

The manufacturer must hand over the following documents to the operator: Declaration of conformity, operator guide, and maintenance papers as well as, if agreed upon, a performance record (please refer to chapter 7) of the machine.

Please note:

For large machines, a test phase is recommended. If so desired, it must be specified before issuing a tender. A factory acceptance test might also be reasonable.

### 6.4 Operating staff

When handing over the machines, the manufacturer must instruct the machine operating staff by introducing them to the operator guide. It is the customer's responsibility, however, to ensure a sufficient instruction of his/her staff (operating instructions). The customer must furthermore compile an occupational risk assessment (based on labour protection laws, ordinances on industrial safety and health, on biological agents and hazardous substances as defined by his/her respective country/EU standards).

### 6.5 Machine log

It is necessary to keep a machine log where all extraordinary incidents (e.g. malfunctions) and routine work (e.g. maintenance and overhaul) as well as changes in adjustment of parameters are recorded.

### 6.6 Operator guide

The operator guide must be provided in the language of the respective country the machines are shipped to and kept on-site in a known accessible location, so all operating staff can consult the guide as needed. A short form of the operator guide must be available and highly visible in close proximity to the operating area.

### 6.7 Standard operating procedure (SOP)

The SOP provides in layman's terms all information necessary for correct and safe operation. The instructions should generally be compiled by the customer, taking the manufacturer's information as a basis. It may be helpful for the customer to use the manufacturers supplied documents, adjusted to the specific situation on-site.

### 6.8 Setting the procedural parameters

When operating the machines, it is recommended to keep the parameters, specified in the operator guide and selected during the test phase. These parameters are for example temperature, dwell time, conveying velocity, concentration of process chemicals, and drying time. If, due to local conditions, it proves necessary to adjust those parameters, it must be recorded in the machine log and, where required, verified with another test phase.

Please refer to in the tables below examples for operating procedures and parameters of programs most common for washers and steam sterilisers:

#### Wash cycle-type washers

Table 6-1

Machine	Cabinet cage washer	Cage and rack washer	Bottle washer
washing temperature	ca 55 - 65 °C	ca 55 - 65 °C	ca 55 - 65 °C
washing time	ca 120 -180 sec	ca 120 sec	ca 60 - 120 sec
rinsing temperature	ca 80 - 90 °C	ca 80 - 90 °C	ca 80 - 90 °C
rinsing time	ca 30 sec	ca 30 sec	ca 20 - 30 sec
drying time	-	ca 60 - 210 sec	-
venting	ca 120 sec	ca 180 sec	-
detergent concentration	2 - 5 ml/l	2 - 5 ml/l	2 - 5 ml/l

## In-line-type washers

Table 6-2

Machine	Tunnel cage washer
washing temperature pre-washing zone	ca 40 - 50 °C
pre-washing time	ca 60 sec
washing temperature washing zone	ca 55 - 60 °C
washing time	ca 120 sec
rinsing temperature	ca 80 - 90 °C
rinsing time	ca 50 - 90 sec
drying temperature	ca 40 - 100 °C
drying time	ca 120 - 240 sec <sup>1</sup>
detergent concentration	2 - 5 ml/l
rinse aid concentration	0,5 - 2 ml/l

<sup>1</sup> The drying time is largely dependent on the desired drying result.

## Steam sterilisers

Table 6-3

Program	Procedure	Fractionations (pulsing)	Steam sterilisation temperature [°C]	Dwell time [min] <sup>2</sup>	Drying time [min]	Cycle time [min]
locks with steam sterilisation	PVP / VWOD	1	134	3	1	ca 20
solids, racks	PVP / VWD	1	134	5	2-5	ca 30
cages, feed, and bedding	FVP / VWD	2 - 4	121	20	10	ca 65
cages made of polycarbonate	FVP / VWD	2 - 4	118	40	10	ca 85
filled water bottles made of polycarbonate	PVP / ICBP	1	118	40	cooling < 80 °C	ca 180 - 220
filled water bottles made of high temperature-resistant plastics <sup>3</sup>	PVP / ICBP	1	121	20	cooling < 80 °C	ca 165 - 205
empty water bottles made of high temperature-resistant plastics <sup>3</sup>	PVP / VWD	1	121	20	2 - 5	ca 50
animal carcasses	FVP / PRAP - VWOD	2 - 4	121 - 134	20 - 60	---	ca 60 - 120
heat-sensitive products	FVP / VWD	4	75 <sup>1</sup>	20	10	ca 60

<sup>1</sup> At 75 °C no steam sterilisation takes place, only sanitization.

<sup>2</sup> Time for the sterilising temperature to act on the items.

<sup>3</sup> E.g. polysulfone, polyetherimide, and polyphenylsulfone

PVP: prevacuum procedure  
 FVP: fractionated vacuum procedure  
 VWD: vacuum with drying time  
 VWOD: vacuum without drying time  
 ICBP: indirect cooling with back pressure  
 PRAP: (slow) pressure relief on atmospheric pressure

## 6.9 Routine checks and measures

The routine measures specified in the operator guide and operating instructions should be implemented at the indicated intervals. These measures include for example:

- check of concentration, temperature, pH value or conductivity of the detergent solution,
- replacement of the detergent solution by emptying the wash tank (please also see chapter 4.3.2.2.4),
- routine cleaning of filters and containers,
- check for clogging and correct spray position of jets (see also notes on maintenance and periodic inspection in chapter 6.11).

## 6.10 Check of washing, drying, and steam sterilisation result

Efficacy checks are of great relevance for an animal facility. For evaluating the performance of washers, the instructions in chapter 7 should be followed. For sanitization procedures with H<sub>2</sub>O<sub>2</sub> / PAA, indications for rating the steriliser performance are provided in chapter 4.6.

If further checks are recommended or required by the machine manufacturer, it must be specified in the operator guide. If the operator wishes additional checks, he/she must give details on those at issuing of a tender for the respective machines.

## 6.11 Maintenance measures

For ensuring a safe and repeatable machine operation, maintenance measures, as required by the manufacturer, including all necessary inspection, maintenance, and overhaul procedures (defined according to DIN 31051), must be done on a regular basis. Only trained experts are to implement these measures. Thereby, attention should be paid to the following aspects:

- All safety instructions must be followed.
- Process parameters must be checked.
- It must be checked if the selected chemicals are suitable for the purpose and used in correct concentration.
- Manufacturer recommended spare parts must be used.

When replacing machine parts that might cause a change in washing process parameters, an extraordinary check is required.

As maintenance work requires specialised knowledge and specific tooling, concluding a maintenance contract with the manufacturer is strongly recommended. Moreover, such a contract might be a prerequisite for asserting warranty claims. A precise assessment and comparison of different maintenance and service quotations, for instance in combination with public tenders, is only possible, if the required maintenance and service activities are adequately specified in advance.

Note: In addition to the maintenance measures in the form of a maintenance contract by the manufacturer, the periodic inspection of the cleaning, decontamination, rinsing and drying results is also recommended, especially for type-tested cleaning systems according to AK KAB. The criteria for periodic on-site inspections are described in detail in chapter 7.6.3.

## 7 Performance evaluation checks for washing systems

For evaluating a flawless operation, it is necessary to check the washing, decontamination, rinsing, and drying performance of a machine. Please find below principle requirements and methods for performance evaluation:

### 7.1 Requirements

#### 7.1.1 Washing

Washing generally means the process of removing soiling off objects to a degree required for further processing or intended item use.

#### 7.1.2 Decontamination

The decontamination process consists of a washing procedure and a process-induced sanitization that is important for further use of an item that requires a defined hygienic status. Steam sterilisation alone is not sufficient. The required status will be achieved with a reduction of microorganisms of, by definition, at least a log<sub>10</sub> reduction factor of 5.

#### 7.1.3. Rinsing

The rinsing process must ensure a sufficient removal of all chemical residues from the items in a processing cycle. When using alkaline or acid detergents, no residues must remain on the items' surface, which can be

verified by means of pH indicators. In specific cases, for instance in toxicology studies, it might be required, that the user check and define particular requirements for tolerable chemical residuals.

### 7.1.4 Drying

Drying means the process of removing water off items inside and outside a washer to a degree required for further processing or intended item use (tolerable residual moisture). The operator must determine, on individual conditions and circumstances, the required degree of drying or if a drying is at all required before issuing a tender.

## 7.2 Test procedures for washing and decontamination of cages, racks, and wire lids

Washing and decontamination tests require specially set up test strips. Although soiling is primarily related to plastic surfaces, this material has low adhesive properties and may affect the properties of the test soiling, for this procedure we have selected strips made of stainless steel, not plastic. Stainless steel pieces are already proven for the test for commercial dishwashers (DIN 10510, DIN 10512) and bed frame and cart decontamination systems (AK-BWA Broschüre – AK-BWA brochure; series of standards DIN 58955) in the medical sector. Please find below a description of the setup of test strips, followed by a description of test procedures.

### 7.2.1 Setup of test strips and test parameters

A test strip must be fixed approximately 5 mm from the surface of the item to be processed. This setup allows for a complete washing around the test strip, reaching also the non-contaminated rear side, and avoids evaluation mistakes resulting from gaps between test strip and real item. The use of stainless steel bolts and spacer nuts is recommended. The contaminated part of the test strip must face the same direction as the item surface to be washed.

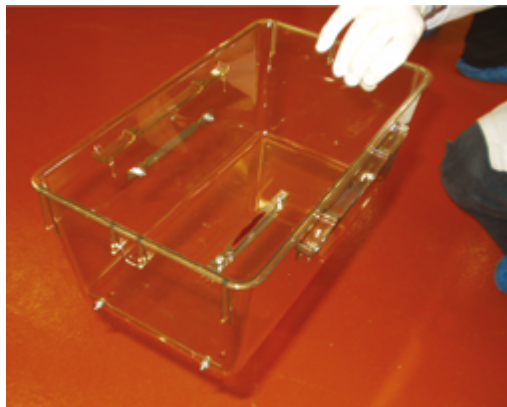

Fig. 7-1 Example test cage

#### 7.2.1.1 Cage bases

##### 7.2.1.1.1 Number of test strips per cage base

5 test strips per cage base

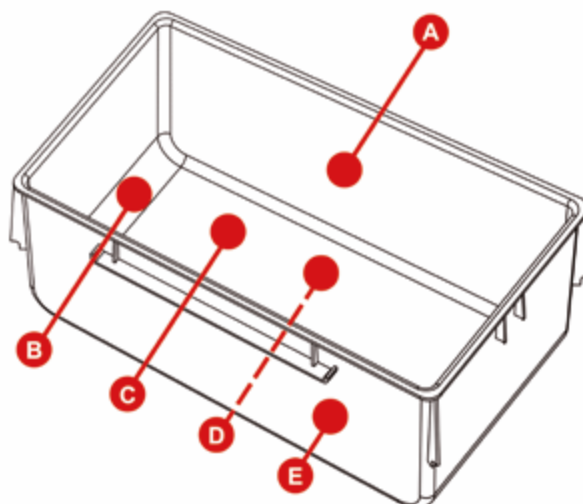

Fig. 7-2 Position of test strip

### 7.2.1.1.2 Test setup

- 1 inside at the long side wall, horizontal (A)
- 1 inside in a corner (B)
- 1 inside mid-floor (C), 1 outside mid-floor (D)
- 1 outside at the long side wall, horizontal (E)

### 7.2.1.2 Wire lids

#### 7.2.1.2.1 Number of test strips per wire lid

2 test strips per wire lid

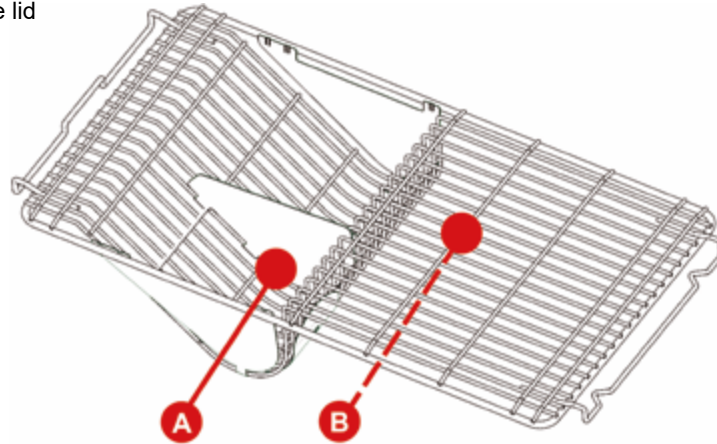

Fig. 7-3 Position of test strip on wire lid

### 7.2.1.2.2 Test setup

- 1 at the feed depression (at the lowest point) (A)
- 1 on the flat wire surface (inside) (B)

### 7.2.1.3 Racks (cage racks as well as storage and transport racks)

#### 7.2.1.3.1 Number of test strips per rack

6 test strips per IVC rack

8 test strips per storage and transport rack

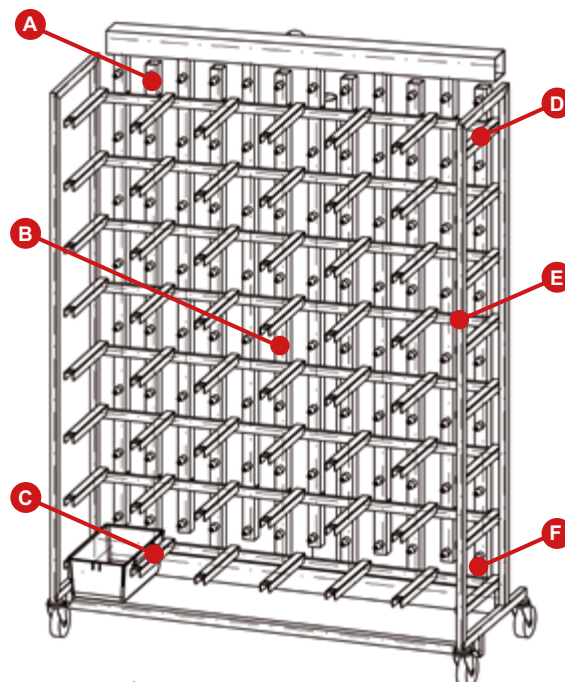

Fig. 7-4 Position of test strip on cage rack

### 7.2.1.3.2 Test setup for IVC racks

- 2 on the runners (C, D)
- 3 local to the extract air nozzles (A, B, F)
- 1 at the front side of the rack frame, outside (E)

Adequate fixings for the pieces are cable ties and suitable spacers. The contaminated side of the test strips and the item surface to be washed must both face the same direction.

**Please note:**

The use of test strips to assess the washing and decontamination performance in the air plenums of IVC racks seems not significant for two reasons:

- The soiling of the plenums depends on a number of complex influencing factors (feed, bedding, air change rate, operation with high and low pressure, etc.), that cannot be standardised for the described test methods with reasonable efforts.
- The geometry of IVC racks can differ a lot, depending on the respective manufacturer, which makes it more difficult to find consistent test methods.

Therefore, the washing performance inside the IVC air plenums should undergo a visual assessment only, without using a test strip.

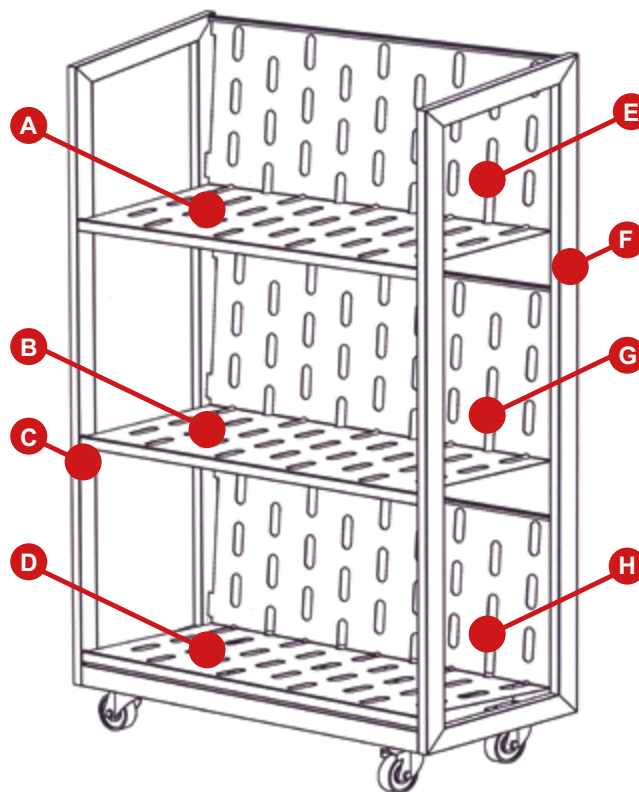

Fig. 7-5 Position of test strip on storage and transport rack

### 7.2.1.3.3 Test setup for storage and transport racks

- 6 over the 3 loading levels (ca 2 test strips per level on loading shelf and back wall, with inclined surfaces preferably in the sheet metal bends / corners (A, B, D, E, G, H)
- 2 at the rack frame, inside and outside (C, F)

### 7.2.1.4 IVC filter tops

Due to their various designs, IVC tops are exceptions and must be considered individually. Therefore, they are not discussed here. Nevertheless, it is strongly recommended to test them as well. The number and setup of the test strips, however, is to be determined on a case-by-case-basis.

### 7.2.2 Test procedures for evaluating the washing of cage bases, wire lids, and racks

For assessing the washing performance, it is standard to use test strips that are contaminated with a test soiling. The number of items and test strips necessary for this procedure, as well as the number of wash cycle series, are indicated in point 7.6. The performance is evaluated on a visual basis.

The levels of assessment are depicted in the listing below:

Clean: No test soiling residues are discernible.



Mildly soiled: Few test soiling residues are discernible.



Soiled: 1/3 of the initially contaminated surface is still covered with test soiling.



Heavily soiled: At least 2/3 of the initially contaminated surface is still covered with test soiling.

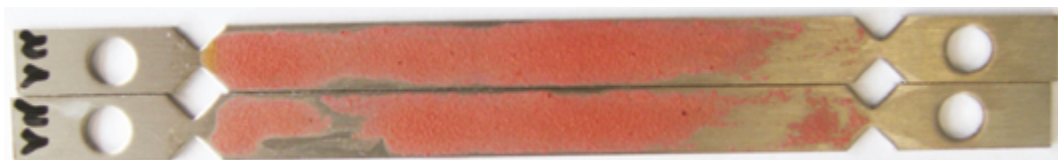

Fig. 7-6 Presentation of test strip showing different cleaning results

**Please note:**

Methyl red is used as dye in the test soiling. However, when using alkaline detergents, potential residues of this soiling might not appear red, but yellow.

With this being said, the acceptance criteria have been determined as follows:

Table 7-1

Items for processing	A sufficient cleaning is achieved when
cage bases	no more than <b>10%</b> of the test strips are <b>mildly soiled</b>
wire lid	
racks (storage and transport racks)	no more than <b>20%</b> of the test strips are <b>mildly soiled</b>
IVC racks (external)	
IVC filter tops	



These acceptance criteria are to be considered as general recommendations. It is possible that, due to special hygienic standards, a washing procedure must meet stricter requirements.

### 7.2.2.1 Producing the test soiling

A test soiling is prepared according to the following procedure:

Weight accurately 10 g urea, 5 g Serva 11930, 10 g Sigma M-2378 and mix all with 3 g vegetable oil in a 250 ml beaker. After that, 13 g cellulose and 1 g calcium carbonate are added, and finally, for colouring, 0.3 to 0.4 g methyl red.

These ingredients are then mixed with 100 ml distilled water. Subsequently heat the entire mixture up while stirring to approximately 50 °C in order to avoid clumping. Furthermore, the test soiling are kept at a constant temperature and stirred during the whole process to prevent segregation. By using a pipette 0.1 ml of the mixture is applied to each test strip and dried for 24 hours at room temperature, before being put in a drying cabinet at 80 °C for another two hours.

Table 7-2

Chemical	Source of supply
urea methyl red Serva 11930 (Albumin Bovine Fraction V pH 7,0) Sigma M-2378 (Mucin Type II Porcine Stomach) cellulose microcrystalline for thin-layer chromatography	FLUKA chemical catalogue, CH-Buchs
calcium carbonate, precipitated	Carl Roth GmbH & Co., Karlsruhe
100% vegetable oil (cholesterol-free)	grocery store

### 7.2.2.2 Test strip for cleaning evaluation

Plates made of stainless steel AISI 304 following DIN 10088-1, grinding grain 80, dimension 10 mm x 130 mm, may be used as test strips. The area designated for soiling amounts to 10mm x 100mm. Before the test soiling is applied, it is necessary to check the piece visually for pre-existing soiled parts. When applying the test soiling, it must be ensured that the side surface stays soiling-free. For an evenly spread application of test soiling on the surface, the test strip must be thoroughly degreased. A multiple use is only possible after a flawless processing of the test strip. After being contaminated, the test strips are stored in a dry place. The time for storing of the contaminated test strips before using them inside the washers should not exceed 1 week.

### 7.2.3 Test procedures for evaluating the decontamination of cage bases, wire lids, and racks

The function of the test procedure described here is to assess the chemical-thermal decontamination for the items to be processed, as mentioned in chapter 3.1.

The number of items and test strips necessary for this procedure, as well as the number of wash cycle series, are indicated in point 7.6. The performance is assessed by means of microbiological count.

#### 7.2.3.1 Test organism

The test organism used in this procedure is *Enterococcus faecium* ATCC 6057 (e.g. by Oxoid GmbH, Wesel). The number of organisms in suspensions for producing the test soiling must add up to at least  $1 \times 10^8$  CFU/ml. The test organisms are grown according to DIN EN 12353.

#### 7.2.3.2 Test strip for decontamination evaluation

Plates made of stainless steel AISI 304 following DIN 10088-1, grinding grain 80, dimension 10 mm x 130 mm, may be used as germ carriers. The area designated for contamination amounts to 10mm x 100mm.

#### 7.2.3.3 Contamination

9 ml of defibrinated sheep blood (e.g. by Acila AG, Mörfelden-Walldorf) are mixed with 1 ml organism in suspension. The produced test soiling is then applied to the test strip. It must be ensured, however, that the side

surfaces stay soil free. For an even application of test soiling on the surface, the test strip must be thoroughly degreased (the use of alcohol alone is not sufficient; it is recommended to use fat solvents or laboratory detergents, or to process the test strip in an automated washer at approximately 60 °C). 0.1 ml of the test soiling is applied evenly to each contaminated area and dried for 24 hours at 22 °C ± 1 °C and a relative air humidity of 50% ± 10% (temperature and air humidity must be recorded in the test report). The testing must be done within 10 days after the test strip was produced. It is recommended to store the test strip at room temperature free of contamination (e.g. in aluminium foil or glass tubes). The number of organisms per contaminated piece must be high enough, considering the detection limit, to allow for evaluation of the reduction factor (at least 1x 10<sup>7</sup> CFU/test strip). Contaminated pieces can be acquired at, for example, SGS Germany GmbH, Hamburg.

#### 7.2.3.4 Evaluation of test strips

After the washer has finished its cycle the test strips are detached under aseptic conditions (e.g. by moving each with sterilised tweezers). Each piece is then examined visually for residues of test soiling before being transferred into a 10 ml phosphate buffer solution (PBS), with inactivating substances, where applicable.

Composition of the phosphate buffer solution (PBS)

Solution A:                    16 g NaCl,  
                                      0.4 g KCl,  
                                      0.4 g KH<sub>2</sub>PO<sub>4</sub>  
                                      To dissolve in 1600 ml distilled water

Solution B:                    0.2 g CaCl<sub>2</sub>  
                                      To dissolve in 200 ml distilled water

Solution C:                    0.2 g MgSO<sub>4</sub>  
                                      To dissolve in 200 ml distilled water

Solutions A to C require a separate Steam sterilisation. After cooling down completely, they should be mixed under sterile conditions, by adding the inactivating substance, where applicable.

The test organisms are recovered by extracting them from the test strips that were transferred into test tubes. The extraction is done by putting the test tube racks on shaking devices with a frequency of approximately 500 rpm for at least 20 minutes. After that, the number of organisms can be determined from the shaken liquid. It must be indicated what method was used.

Parallel to that, the transport controls are equally transferred into 10 ml PBS and analysed, without being treated in the washer.

Valid methods for determining the number of organisms are:

- dilution series and surface culture,
- spiral plater.

A suitable selective culture medium (e.g. Kanamycin Esculin Acid Agar) can help suppress the growing of other organisms. The incubation time of the spiked culture media at 36 ± 1 °C is 48 hours. It must be indicated what methods were used for determining the number of organisms as well as what culture solutions and culture media were used.

The reduction of organisms count results from the difference of the number of detected CFU of test organisms on the treated test strips and from the average value of the three untreated test strips (transport controls). Against this background the following acceptance criteria was defined: The reduction factor must at least add up to 5 lg levels with 90% of the used test strips.

### 7.3 Test procedures for washing and decontamination of water bottles

With water bottles, the washing performance is assessed by means of test soiling directly contaminating the bottle surface.

### 7.3.1 Washing

The washing performance is assessed according to DIN 10511. The water bottles are contaminated directly with test soiling. No extra test strips are needed. The relevant test number of items as well as the number of the wash cycles are indicated in table 7-2. The assessment is done on a visual basis.

#### 7.3.1.1 Producing the test soiling

The test soiling for contamination is made of reconstituted skimmed milk. For producing 100 ml of reconstituted skimmed milk, 10 g skimmed milk powder is mixed with 100 ml distilled water. The mixture must be stirred vigorously before being steam sterilised for 5 minutes at 121 °C. For extra good adhesion, 13 g cellulose should be added before sterilising.

Table 7-3

Chemical	Source of supply
spray-dried skimmed milk powder	pharmacy
cellulose (microcrystalline for thin-layer chromatography)	FLUKA chemicals catalogue, CH-Buchs

#### 7.3.1.2 Applying the test soiling

A water bottle should be half-filled with test soiling and be emptied by giving it a rotation in a tilted position, so the entire inside of the bottle is wet with test soiling. For wetting the bottle rim, it is recommended to dip the rim 1 cm deep into the test soiling. The drying process takes 2 hours altogether with the bottles being first placed upside down in a bottle crate and turned over after an hour.

The assessment is done visually and differentiates between clean and soiled bottles (please refer to figures below). Acceptance criteria: All test bottles must be visually clean.



Figure 7-7 Bottle with contamination

Figure 7-8 Bottle still dirty

Figure 7-9 Bottle clean

### 7.3.2 Decontamination

Water bottles do not get soiled and contaminated as much as cages and other items for processing do (e.g. with excrement, urea, etc.). Therefore, the decontamination of water bottles is not equally relevant. Although it is generally possible to check water bottles for decontamination, it needs a very complex procedure. The reason is, that there are no standardisable test strips, and each bottle type would have to undergo an individual procedure. It is therefore recommended by the working group to sterilise water bottles whenever a hygienic standardisation of the processing procedure for water bottles is required. This approach is also common practice.

## 7.4 Test procedure for confirming the rinsing of cage bases, wire lids, racks, water bottles, and bottle caps

When using alkaline and acid detergents, the rinsing effectiveness can be tested by means of pH indicators. The effectiveness is tested on the items after the rinsing procedure is finished.

An approximate determination of the effectiveness of the final rinse can be achieved with the following indicators:

Table 7-4

Detergent	pH Indicator	pH Change range	Implementation	Colour reaction
alkaline	phenolphthalein solution*	9,4 - 10,6	Residual moisture is soaked up with a cloth. For determining the pH value, the cloth is wetted with a few drops of indicator solution.	reddish purple indicates alkalinity
alkaline	phenolphthalein paper	9,4 - 10,6	Following the manufacturer instructions, the paper is dipped in or wetted with adherent residual moisture. The colour value can then be read off the paper.	reddish purple indicates alkalinity
acid	methyl orange**	3,0 - 4,4	Residual moisture is soaked up with a cloth. For determining the pH value, the cloth is wetted with a few drops of indicator solution.	Red indicates acid; else the indicator solution would be yellow-orange.
alkaline and acid	litmus paper	all pH ranges	Following the manufacturer instructions, the paper is dipped in or wetted with adherent residual moisture. The colour value can then be read off the paper.	according to manufacturer instructions

\*1% in ethanol / \*\*highly diluted solution (0,04g methyl orange per 100ml of 20% ethanol)

**Please note:** Due to its alkalinity, softened rinsing water can misleadingly indicate residues of alkaline detergents. (Demineralised water that is often used for rinsing can have an “acid” pH value and misleadingly indicate residues of acid detergents.)

A more accurate way to test the rinse effectiveness can be done with pH indicator sticks. For this purpose, it is recommended to take the following samples beforehand and to carry out the described measurements, which should also be documented:

- Sampling of the rinse water entering the washer (on-site supply line), subsequent measurement of the pH value (e.g. with pH indicator strips, see Fig. 7-10).
- Sampling of the rinse water prepared in the washer (from the rinse tank), subsequent measurement of the pH value (e.g. with pH indicator strips, see Fig. 7-10).
- Documentation of the process chemicals used for cleaning and rinsing and their dosing concentration.
- In addition, it is recommended to document the amount of water used for rinsing in a cycle or in a certain time (e.g. per hour).

Now the cleaning chamber is loaded with the maximum possible number of e.g. cage bases and a cleaning and rinsing process is started. At the end of the cycle, the pH value of the remaining adhesive water on the surface (on all surfaces, inside, outside, sides) is checked on 10% of the loaded cage bases using pH indicator strips. For this purpose, residual drops are picked up with the pH indicator stick and the colour change and the indicated pH value are documented. This process is repeated for a total of 3 cycles with a new cage load.

The acceptance criterion for effective rinsing is that a total of 90% of all tested cage parts preferably have a neutral pH value (7.0 with tolerance +/- 1.0) of the adhesive water on the surfaces. If the pH value measured in the incoming rinse water into the washer deviates significantly from a neutral pH value (see notes on this above), this must be taken into account when evaluating the results.



Figure 7-10 Example pH indicator sticks

### 7.5 Test procedures for drying of cage bases

The drying result is assessed visually. The levels of assessment are depicted below:

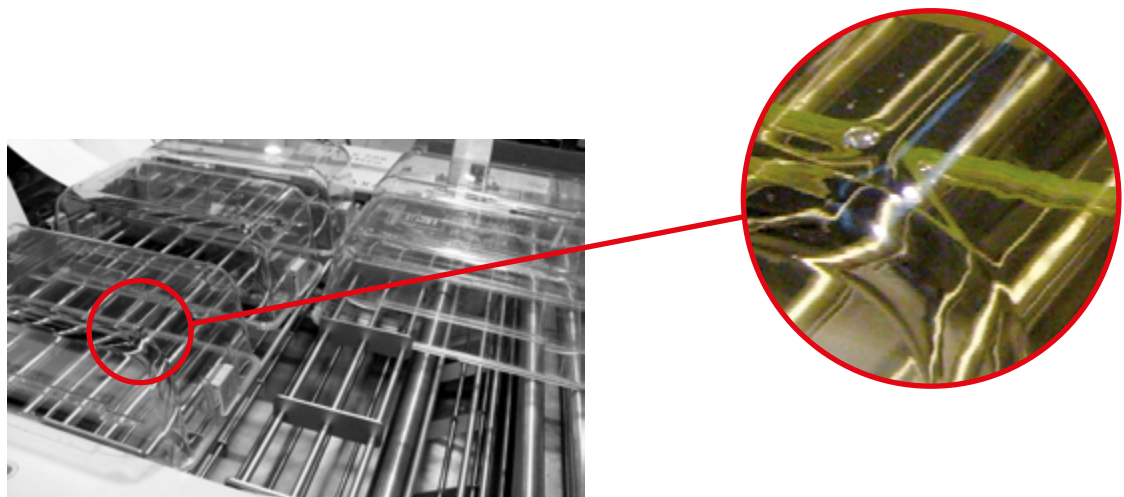

Figure 7-11 Cage body, without any visible water residues or drops left - Level 1

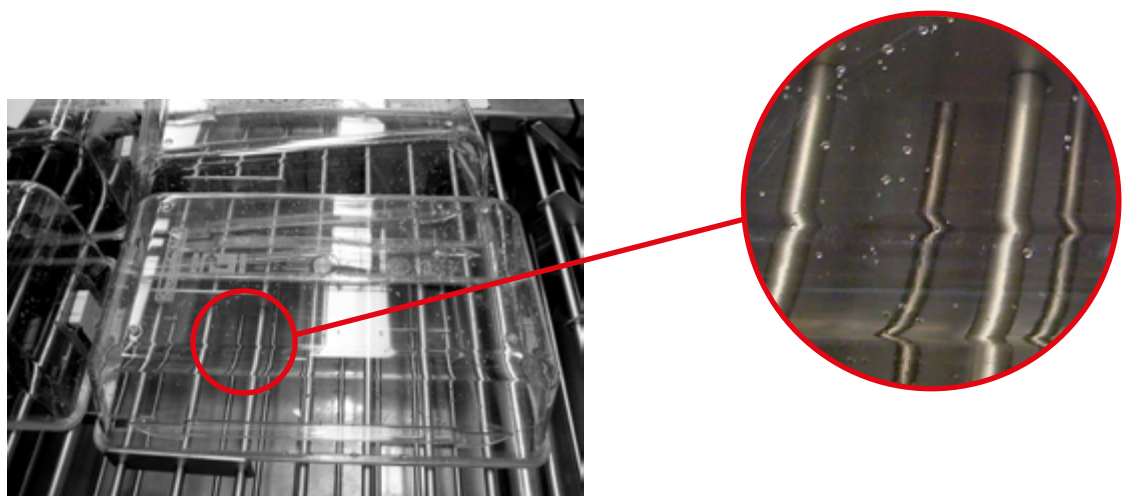

Figure 7-12 Cage body, only some drops visible - Level 2

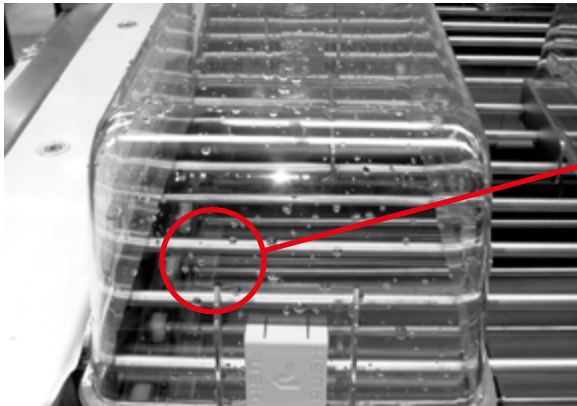

Figure 7-13 Cage body, numerous drops visible - Level 3

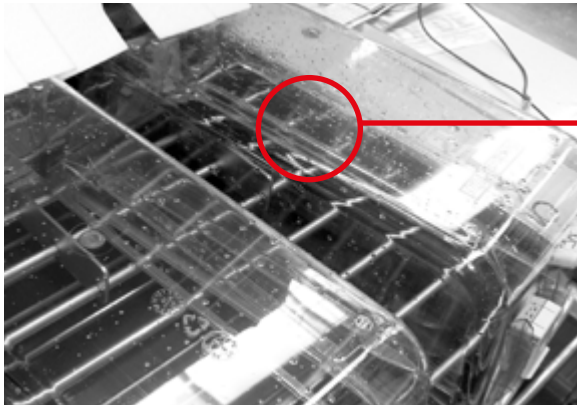

Figure 7-14 Cage body, large parts of the surface covered with water - Level 4

## 7.6 Types of test procedure

The types of test procedure are as follows:

Type test, test after assembly, periodic inspection, extraordinary inspection; please refer to table 7-1.

Table 7-5

Type test at the manufacturer's site (chapter 7.6.1)	AK-KAB-developed procedure for evaluating the performance of a machine type. The type test is implemented at the factory with the manufacturer specifying the machine types (or type series) the tests are valid for (please refer to table 7-6).
Test after assembly (chapter 7.6.2)	Systematic test equal to type test, but with on-site resources. It is up to the operator to decide the kind and range of tests to be implemented (e.g.: washing, decontamination, rinsing and/or drying). The amount of investigation on site can be reduced, in cases a type test at the manufacturer's site (7.6.1) was done for the washer in advance.
Periodic inspection on site (chapter 7.6.3)	Periodic inspection, recommended on a yearly basis (please refer to table 7.7).

Extraordinary inspection (chapter 7.6.4)	Inspection on site after process-interfering repairs, program changes, changes in process chemicals or in items for processing.
------------------------------------------	---------------------------------------------------------------------------------------------------------------------------------

The AK KAB recommends to select exclusively type tested washers only, in order to avoid the purchase of none suitable washers. A sample of a self-declaration, where the manufacturer unambiguously needs to confirm the results of the type test, is part of the chapter 12. In addition AK KAB points out that washers should be periodically inspected (extraordinary if necessary) on site, to guarantee a safe operating after installation.

### 7.6.1 Tests at the manufacturer's site (type test)

The tests performed at the manufacturer's should imply a testing of the washing performance (please refer to 7.2.1 and 7.2.2), decontamination performance (please refer to 7.2.1 and 7.2.3), rinsing performance (please refer to 7.4) and drying performance (please refer to 7.5).

Table 7-6

Washer	Items for processing			
	Cage base	Wire lid	IVC rack	Storage and transport rack
Cabinet cage washer (3 cycles each)	10%*	1 stack with 3 wire lids put on top of each other, test strips only at the middle lid, 10 % of the stack*	-	-
Tunnel cage washer (in 15 min)	10%*	1 stack with 3 wire lids put on top of each other, test strips only at the middle lid, 10 % of the stack*	-	-
Cage and rack washer (3 cycles each)	10%*	1 stack with 3 wire lids put on top of each other, test strips only at the middle lid, 10 % of the stack*	1	1

\* of the loading capacity

When testing the washing of bottles at the manufacturers, the procedure is as follows: Bottles are usually machine washed. In each machine two 18 bottle crates are placed parallel to each other. For this configuration, the following X marked bottles are to be checked over 3 cycles.

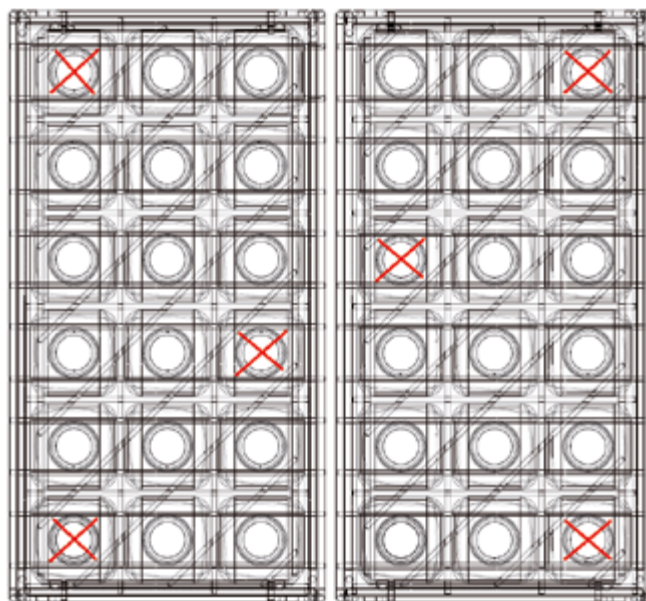

Figure 7-15 View of two bottle crates with 18 bottles each

With other configurations, test setups must be used where at least 20% of the bottles are checked. The test bottles must then be placed in critical spots with regard to machine type, spraying geometry, loading configuration, etc.

### 7.6.2 Test after assembly

Testing a washer after assembly is a decision taken by the customer. When choosing to test, the customer should implement the same test procedure as when testing the machine at the manufacturer's (please refer to 7.6.1), only by using the utilities on-site. If the customer wishes a test after assembly, as recommended by the AK-KAB, it has to be ordered separately.

### 7.6.3 Periodic inspection on site

A periodic check is the responsibility of the operator. The test is recommended once a year in order to verify that a washer still meets the necessary requirements. A periodic testing of the items for processing listed in Table 7-3 should be sufficient.

Table 7-7

Washer	Items for processing			
	Cage base	Wire lid	IVC rack	Storage and transport racks
Cabinet cage washer (one cycle)	2	1	-	-
Tunnel cage washer	2	1	-	-
Cage and rack washer (one cycle)	2	1	1	1

A periodic check of the washing performance of bottle washers should be done as it was described for the type test. Here, the test, however, can be reduced to one cycle.

**Please note:**

When checking surfaces for cleanliness, the food industry uses an adenosine triphosphate (ATP)-bioluminescence procedure. This method provides a check for organic residues containing ATP. Although it can be tested if a surface is free from organic residues and is to be rated as "clean", the ATP method is no evaluation of the washing process itself, as there is no established initial contamination. Therefore, ATP is no appropriate substitute for bio indicators that show a defined initial level of organism exposure. This also applies for evaluating the washing performance that should undergo a standard procedure. Please also note that the result of the ATP measuring is highly dependent on external factors like particles on the surface, residues of process chemicals, or condition of the surface to be checked. Therefore, the AK-KAB recommends the use of bio / cleaning indicators for all types of testing. If the ATP method is applied for periodic inspection, it should only be used as an additional procedure. Thereby, swabs are taken, using a standard pattern where applicable, of ten items placed in critical, hard to clean spots. ATP is then verified inside a luminometer by emitted light, generated in a luciferin / luciferase reaction.

### 7.6.4 Extraordinary inspection

After process interfering repairs, program changes, changes in process chemicals or items for processing, an extraordinary inspection is recommended. It is up to the operator to decide if an inspection is needed. The inspection is done according to the customer's requirements and the degree of interference. The extent of the extraordinary inspection, depending on the type of procedure interference, can range between a test after assembly and a periodic inspection.

## 7.7 Bottle caps

For the check of bottle caps for cleanliness the following recommendations are made.

- After washing, a visual check should be implemented.
- Before reinserting the bottles in the cage, the functioning of the cap nozzles should be checked (refer to chapter 9.6).



## 7.8 Sustainability inspection

The tests described in great detail in this chapter for the performance assessment of washers consider the cleaning, decontamination, rinsing and drying results to be achieved, as they are usually required in animal facilities. In addition to this performance, nowadays the media consumption and thus the economic operation of the machines as well as their sustainability are also evaluated. The European Society for Sustainable Laboratory Technologies e.V. (EGNATON) has defined criteria for washers, taking into account the recommendations of the German Sustainable Building Council (DGNB), with which the sustainable operation of systems can be checked. To check for sustainability, the performance defined in chapter 7 is used and set in relation to the media consumption. Further information on this can be viewed and downloaded at <http://www.egnaton.com/de/CERT.aspx>.

## 8 Ecological requirements

Processing machines for animal cages, water bottles, racks, and other items used in laboratory animal facilities must produce flawless results for the life of operation, consuming as little energy, water, and chemicals as possible. Thus, for ecological reasons, processing machines should meet the following requirements:

### Water

Regarding water consumption, washing procedures are to be preferred where water can be partially reused. Rinsing water used for items that have been washed with alkaline or acid detergents, or rinsing water mixed with rinse aid, for example, can be reused without affecting the cleaning success. A final rinsing, however, should always be done with pure fresh, demineralised water or with fresh demineralised water mixed with rinse aid.

### Energy

A flawless operation needs a certain amount of energy. To keep this energy expenditure as low as possible, it is necessary to exploit all economically useful, state-of-the-art capabilities.

### Process chemicals

A constantly satisfying washing result requires a steady concentration of process chemicals during the life of operation. To ensure an exact dispensing of chemicals for the operator, manufacturers of washers and process chemicals offer a number of dispensing devices up to centrally operating dispensing stations. A chemical overdosing would entail preventable environmental pollution, an underdosing a poor washing or rinsing result. Process chemicals must be developed from resources that ensure a best possible protection of the environment. Depending on the characteristics of the soilings to be eliminated, detergent solutions can have an acid to alkaline pH range. Rinse aids usually have a mildly acid pH value.

The most important ingredients of process chemicals are:

#### *Alkalis*

Alkalis contribute to the washing process by expanding and removing organic soil residues, like starch, protein, and fat. This leads to a high (alkaline) pH value of the detergent solution. In the internal drainage system of a facility, however, alkalis are diluted by being mixed with other liquids, in part acid waste water. Thus, the pH value of the washing waste water will be reduced to the limit value commonly defined in Sewage Law. If this is not the case, a neutralising system should be built in.

#### *Phosphates*

Phosphates bind the water's hardness components and contribute to the washing process by their emulsifying and dispersing effect. Besides inorganic nitrogen compounds, phosphates are among the most important nutrients in water. Excessive phosphate supply will lead to an intensified bio production (overfertilisation). In sewage plants with a precipitation level (3<sup>rd</sup> level) phosphates are widely eliminated.

#### *Phosphate substitutes*

Phosphate substitutes can replace real phosphates in limited situation. Just as real phosphates, they are used for binding water hardness. However, the use of substitutes for this purpose cannot be fully recommended due to ecological objections, like their lack of biodegradable properties.

#### *Active chlorine carrier*

Active chlorine is used for reduction of organisms and oxidative decomposition of organic residues. As active chlorine, due to its property of generating AOX, is rated as pollutive, its use is increasingly abandoned.

### *Surfactants*

Surfactants reduce the surface tension of the detergent solution or rinsing water and must be biodegradable, which means they are degraded in a sewage plant with help of microorganisms.

### *Acids*

Inorganic or organic acids in acid detergents help remove mineral residues. Rinse aids bind the residual hardness of rinsing water and prevent deposits of calcium. The use of acids leads to a low (acid) pH value of the detergent solution. In the internal waste water system of a machine or facility, however, acids are diluted by being mixed with other waste water. Thus, the pH value of the washing waste water will be neutralised to the limit value commonly defined in Sewage Law. If this is not the case, a neutralising system should be built in.

### **Trading unit**

Trading units of process chemicals should be made of plastics (like PE or PP) that help save the environment as best as possible. Before disposing used units, they must be completely emptied of residues. The frequency of disposing of empty plastic units can be reduced by using large refillable units.

### **Hydrogen peroxide and peracetic acid**

Hydrogen peroxide (H<sub>2</sub>O<sub>2</sub>) or peracetic acid (PAA) are often used in locks for reducing organisms on heat-sensitive items. As these substances, especially when concentrated, are harmful for the environment, they must be handled with special care. It is recommended to consult the respective safety data sheets and follow the therein indicated notes on disposal. Further information on H<sub>2</sub>O<sub>2</sub> and PAA can be found in chapter 4.6.

### **Waste water**

Operators of washers in laboratory animal facilities usually discharge their waste water indirectly and must follow the waste water regulations set by the local authorities. These regulations can differ, depending on each city or community. It is necessary for the operators to pay a sewage charge covering the costs for the discharged waste water, public waste water system, operation of sewage plants, and waste water monitoring. In order to motivate operators to reduce the amount of contaminants they discharge, many cities and communities have introduced so called sewage coefficients, rating, by means of data analysis, the actual contamination caused by each indirect discharger. On the basis of this contamination data, an individual, operator specific sewage charge is calculated (polluter pay principle).

Apart from this operator specific sewage charge, there are also mandatory water pollution limits for indirect dischargers, based on federal law that may not be exceeded. Due to high dilution, biocidal agents and other ingredients of process chemicals do not affect the biological treatment of waste water in sewage plants. When reaching the allowable limit of waste water temperature in a washer, the waste water can be cooled down by feeding cold water.

### **Exhaust air**

In animal facilities, there are three types of exhaust air to be considered:

- general exhaust air coming from the processing centre (and being discharged via on-site vent pipes),
- exhaust air coming from washers and steam sterilisers,
- exhaust air coming from bedding handling systems.

Exhaust air from washers and steam sterilisers is often very humid and warm. It is discharged from the machine during and after the washing process through on site vent systems containing either a permanent connection or an exhaust air chimney. A system for heat recovery might be useful. Due to process temperatures and chemicals, the exhaust pipes of a facility must be temperature resistant, watertight, and above all corrosion resistant. Recommended materials are plastics (e.g. PP – polypropylene, PVC – polyvinyl chloride) and stainless steel.

With exhaust air coming from bedding handling systems, the following distinction must be made:

Mobile bedding disposal systems usually operate with recirculation air, which means they feed back the exhausted air in a clean state. It is important to use high-quality filters (H13 at least) in order to filter out solid particles. A sustainable neutralising of vaporised substances (odours) is very difficult and interference must be expected.

In stationary bedding disposal systems with vacuum transport, fine dusts and unpleasant smells are also exhausted. It is important, however, to ensure that the exhaust air of these machines is not fed back but dischar-

ged through pipes in the roof or fed into the animal house exhaust air system.

Bedding dispensing systems, too, require fine particle filters of high quality. With these systems, however, no unpleasant smells occur. Therefore they can be used for recirculated air operation.

Exhaust air, coming from material locks which are used for treatment of items with hydrogen peroxide (H<sub>2</sub>O<sub>2</sub>), contains depending on the process a high concentration of H<sub>2</sub>O<sub>2</sub>. After sterilisation the exhaust air is routed directly into the in-house exhaust air system via a fixed connection. Because of the toxic, oxidative and condensing properties of hydrogen peroxide, the one-site exhaust air ducts must meet following requirements: airtight, watertight and corrosion resistant. Ideally plastic material (e.g. PP - polypropylene, PVC –polyvinyl chloride) or stainless steel is required.

**Heat dissipation**

Manufacturers of washers and sterilisers must minimise the heat dissipation in an economically and technically responsible way. The customer is required to insulate the steam pipes against heat dissipation (please refer to heat insulation ordinances as defined by your respective country/EU standards).

**9 Potential defects and damages in items for processing**

In animal facilities, it is not uncommon that items for processing (please refer to chapter 3) soon suffer surface changes, in form of deposits, corrosion and stress / micro cracks, which might make it necessary to replace them. Usually, these damages do not result from natural, unavoidable wear, but from physical and chemical influences due to improper treatment. Depicted below are the most important causes of defects and damages in items being processed as well as suitable preventative measures.

**9.1 Material haze (when using polycarbonate)**

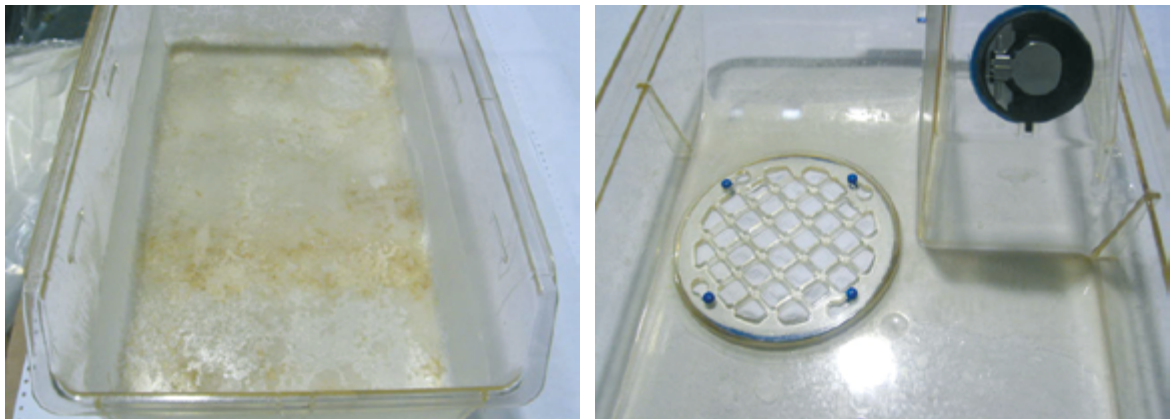

Figure 9-1 on the left a cage body, on the right a cage lid with material haze

Table 9-1

Source and causes	Preventative measures
With insufficient rinsing and subsequent steam sterilisation, residues of alkaline detergents on polycarbonate items can cause material decomposition.	All items and their surfaces must be sufficiently rinsed to ensure that all alkaline detergents are removed.
Softened water, particularly after being heated, shows an alkaline reaction. This reaction, characteristic for the softening process, can be ascribed to a cationic exchange of raw water inherent calcium and magnesium hardness components against sodium salts and the thus generated alkaline sodium carbonate. When sterilising an item made of polycarbonate, still adherent softened rinsing water can lead to material decomposition.	When rinsing items, the use of demineralised water and/or acid rinse aid is recommended.

When generating steam, alkaline correction chemicals can also cause material decomposition of polycarbonate items.	When generating steam, it should conform to the specifications in EN 285.
Sterilising cages together with highly resinous bedding (pinewood) can also lead to material decomposition.	Resin-free bedding materials should be considered (hardwoods like aspen, birch, poplar).
When items, and cage bases in particular, are transferred from an infectious barrier area by means of steam sterilisation, items made of polycarbonate will soon suffer material haze.	When transferring cages out of a barrier area by autoclaving, it is recommended to use cages made of polysulfone, polyetherimide or more significant material.

## 9.2 Material haze (when using polysulfone and polyphenylsulfone)



Figure 9-2 on the left a cage top and drinking bottle made of polysulfone with milky white material haze, and on the right a detailed view of a cage top

Table 9-2

Source and causes	Preventative measures
<p>This type of damage is a material swelling of the surface, which manifests itself in a milky white material haze.</p> <p>According to the current state of knowledge, studies show that this haze can occur if these surfaces are frequently exposed to natural and / or artificial daylight and sunlight (UV), e.g. in the cleaning area, in animal husbandry and / or storage rooms, and these plastic parts are then also regularly sterilised.</p> <p>If one of these two factors (UV exposure or sterilising) does not apply, experience shows that there is no comparable material change.</p> <p>The investigations also show that this material haze can be attributed to the chemical-physical properties of these plastics and is therefore independent of the manufacturer.</p> <p>Based on the findings to date, there is no evidence of any loss of quality in terms of stability and mechanical durability.</p>	<p>Use suitable UV filters for the UV spectrum with artificial daylight in the illuminant.</p> <p>Avoid sterilising if possible.</p>

### 9.3 Deposits

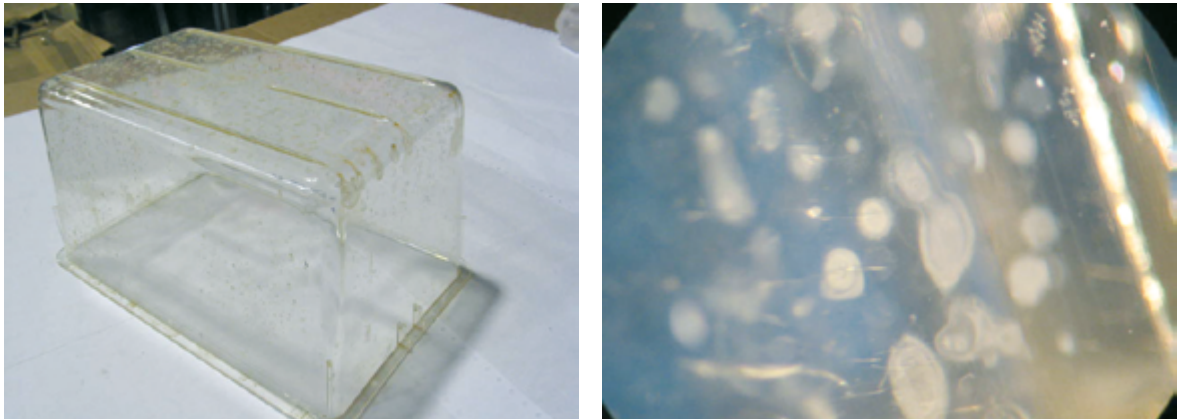

Figure 9-3 on the left a Cage body with deposits, on the right a detailed view of a cage body

Table 9-3

Source and causes	Preventative measures
Urinal scale and/or lime can cause deposits on the surface of the items.	Items should be washed with acid detergents.
When washing items with hot water, blood residues, due to coagulation, can cause deposits, too.	A manual pre-washing and/or soaking of items in cold water is recommended, also used with alkaline detergents.
Washing-related residues also lead to deposits.	All items must be sufficiently rinsed to ensure that detergents are fully removed.
Using water of insufficient quality can result in residues or desposits, especially on items with gaps and hollows where liquids cannot run off.	The use of softened water or preferable demineralised water for rinsing is recommended.
Deposits can also occur during steam sterilisation when bad quality steam or harmful ingredients are used.	When generating steam, it should be conform to the specifications in EN 285.

### 9.4 Stress / micro cracks



Figure 9-4 on the left a Cage body with micro cracks, on the right a detailed view of a cage body

Table 9-4

Source and causes	Preventative measures
Stress / micro crack sensitive plastics, like polysulfone or polyphenylene oxide (Noryl®), can suffer stress / micro cracks during steam sterilisation, when using unsuitable rinse aids (or anti spotting agents) for rinsing beforehand.	The use of special, material adjusted rinse aids is recommended. Please contact the cage manufacturer in advance!
Severe mechanical impact due to a mishandling of cage bases (incorrect emptying, vigorous scraping out of bedding, pushing of bases over abrasive and edged surfaces) can cause crazing and scratches that might lead to more severe cracking and other damages in the process of steam sterilisation.	Suitable utensils, like plastic scrapers and hand brushes, are recommended. A careful handling, carrying, and accurate storing of items should be ensured.
Using unsuitable steam sterilisation bags for plastic items can lead to stress / micro cracks or even destruction of the items.	It is recommended to use suitable, steam permeable steam sterilisation bags or closed, steam permeable steam sterilisation containers.

## 9.5 Deformations

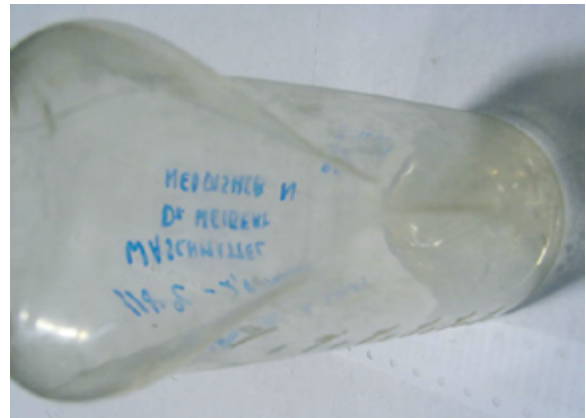

Figure 9-5 Bottles with deformations

Table 9-5

Source and causes	Preventative Measures
When washing and sterilising items with excessive temperatures, depending on the type of plastics, may cause material deformations.	Following the maximum allowable washing and steam sterilisation temperature and time for the respective plastics (please refer to chapter 3) is strongly recommended. Please note the manufacturers' instructions!
High stacking of cage bases for carrying or steam sterilisation can cause material deformations.	Stacking heights, depending on cage dimension and material, should be reduced to 20 bases max during these processes. Please note the manufacturers' instructions!
Sterilising cage bases with closed and locked tops can cause deformations in the locking devices (e.g. holders), that might lead to a loss in function.	Cage bases and tops should be sterilised separately, or, when tops are closed, they should be unlocked.
Overheating an item during steam sterilisation leads to material softening. In case of water bottles, this might result in deformations and leakage. Reason: In order to heat liquids in water bottles to 121 °C within reasonable time, it is necessary to use a higher steam temperature of for example 124 °C. Polycarbonate, however, reaches its material limit at approximately 123 °C.	There are two preventative options: A. Using a lower steam sterilisation temperature (e.g. 118 °C). B. Using water bottles made of polysulfone, as this material tolerates a steam sterilisation temperature of 134 °C. <b>Please note:</b> Bottles with tapered neck (without silicone sealing ring) should never be steam sterilized with caps on.

### 9.6 Damage to plastic goods due to the use of unsuitable autoclave bags

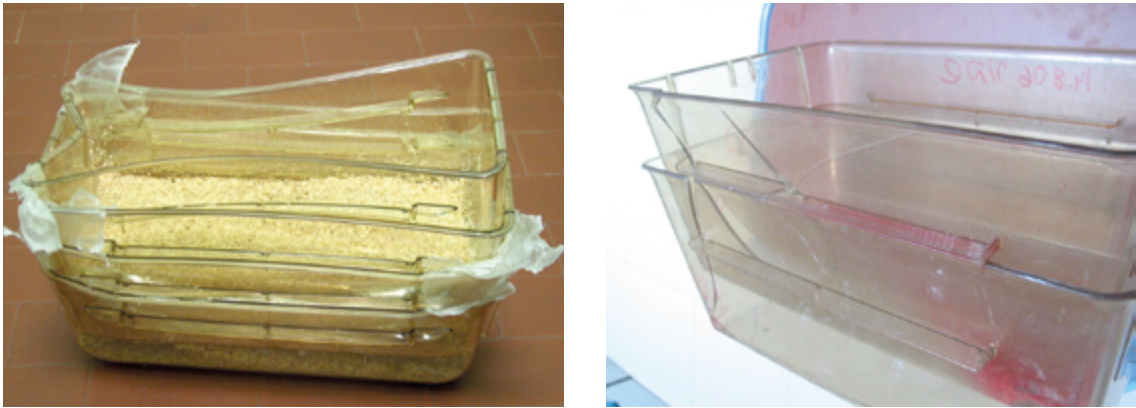

Figure 9-6 on the left deformation in cage bodies, on the right cracks in cage bodies

Table 9-6

Source and causes	Preventative Measures
<p>If unsuitable sterilisation autoclave bags are used, the following damage may occur to the plastic items.</p> <ul style="list-style-type: none"> <li>- Crack formation</li> <li>- Irreversible, plastic deformations (e.g. at the stacking corners)</li> </ul>	<p>Use of suitable, steam-permeable autoclave bags or closed, steam-permeable sterilisation containers.</p>

### 9.7 Corrosion/pitting/extraneous rust in stainless steel (AISI 304, AISI 316)

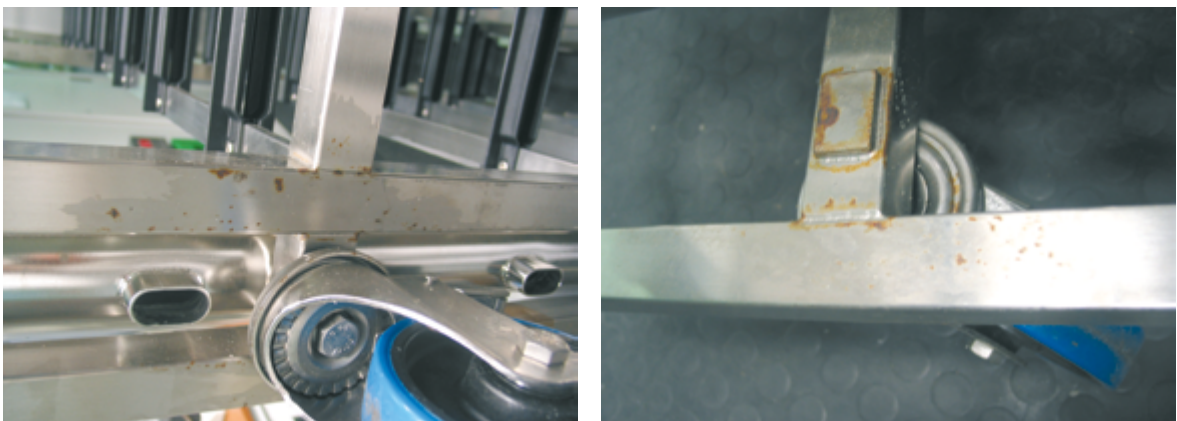

Figure 9-7 Stainless steel racks showing corrosion

Table 9-7

Source and causes	Preventative measures
<p>Initial drying of disinfectants containing chlorine, or evaporation of floor cleaners etc. containing hydrochloric acid can cause chlorine induced pitting on stainless steel.</p>	<p>In order to remove these disinfectants after the specified dwell time, a sufficient rinsing is recommended. Alternatively, a chlorine free disinfectant can be used. Detergents containing hydrochloric acid should be avoided.</p>
<p>Any improper use (e.g. insufficient rinsing) of detergents containing active chlorine leads to pitting.</p>	<p>Items must be sufficiently rinsed to ensure that detergents are fully removed.</p>

If drinking water is acidified with hydrochloric acid, residues of acidified water can cause chlorine induced pitting on stainless steel parts.	The use of other acids like sulphuric acid or phosphoric acid is recommended.
Extraneous rust contamination from water and/or steam pipes can cause rust deposits onto surfaces.	It is recommended to use suitable pipes (e.g. made of plastics or stainless steel) or to pre-treat the water accordingly (for limit values, please refer to 5.2.1 and 5.2.2).

## 9.8 Problems during treatment of the bottle drinking nipples

(Bottle nipples release reduced volume or no water)

Table 9-8

Sources and causes	Preventative measures
<p>Washing of bottle caps in washers designed for cages.</p> <p>Thus can cause clogging of the bottle nipple due to a carry-over of bedding particles.</p> <p>Improper usage of detergent or even no use of any detergent.</p>	<p>Treatment of bottle caps in special designed washing machine (e.g. bottle and bottle cap washer with individual water jet configuration).</p> <p>Usage of adequate detergents (e.g. acid detergent)</p> <p>Avoid cleaning of caps in a washer after that has been used to process cages with remains of bedding. Or: mechanical cleaning of the caps only after a basic cleaning cycle of the washing machine to avoid a carry-over of particles.</p>
<p>Overloading of the presentation baskets with bottle caps.</p> <p>Usage of unsuitable containers during washing of caps, for example plastic baskets with small openings which cause an insufficient or even no water coverage.</p>	<p>When cleaning caps in baskets randomly accommodated, the number of caps should be limited in order to ensure a complete coverage with water on the inner side.</p> <p>For a suitable and secure processing of the caps the usage of wire baskets is recommended, to minimize the spray shadow.</p> <p>For special requirements a particular design of baskets is available, with a defined arrangement of the bottle caps enabling a targeted spot cleaning.</p>
<p>Remainder of oily, fatty substances – also small amounts – could lead to partly or fully clogging of the bottle (refer to figure 9.8 left).</p>	<p>Review of quality of the on-site compressed air used for pneumatic decapping and sterilisation (supporting pressure) to avoid oily residues in the compressed air (refer to chapter 5.2.4).</p> <p>Review of compliance of the on-site steam quality according to steam specification EN 285 (refer to chapter 5.2.2.2) to avoid substances like corrosion inhibitors in the steam. This would cause an oily layer in the bottle nipple.</p> <p>Review of compliance of the on-site water quality to avoid oily residues in the water supply for the bottle filling procedure (refer to chapter 5.2.1).</p> <p>If applicable evaluate the suitability of the grease applied to the door seals of the sterilizer.</p>



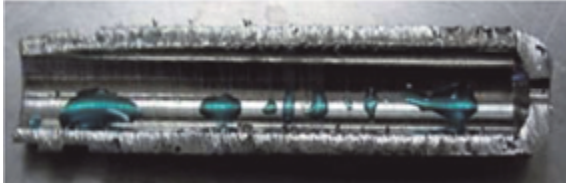

Figure 9-8 **left** Cut bottle nipple with inadequate water flow. Incomplete water wetting on the inner side of the capillary clearly visible

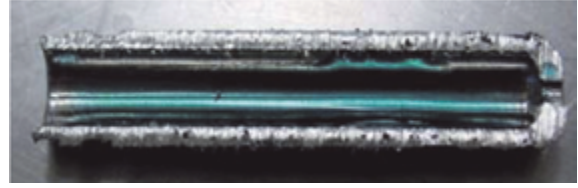

Figure 9-8 **right** Cut bottle nipple with trouble-free water flow

If there are already problems with incorrect treated bottle caps, a prolonged washing cycle using alkaline detergent must be conducted. A pre-treatment is required for oily or fatty deposits of 20 minutes in an ultrasonic bath with 5% alkaline detergent solution, followed by a normal washing cycle of the caps and finally a prolonged post cleaning with fresh demineralised water.

A simple procedure is in place to test the performance of the bottle nipple, the trouble-free water flow. (Could be performed on a regular basis or when needed):

- Fill a bottle with water
- Close it with the cap
- Position the filled bottle into the bottle depression of a cage/IVC lid
- Wait for 20 seconds, till water and air are in balance
- Touching the top of the nipple with the finger, a water drop should be pulled off/released (see figure 9-8) – If this is not possible above mentioned causes and measures should be evaluated

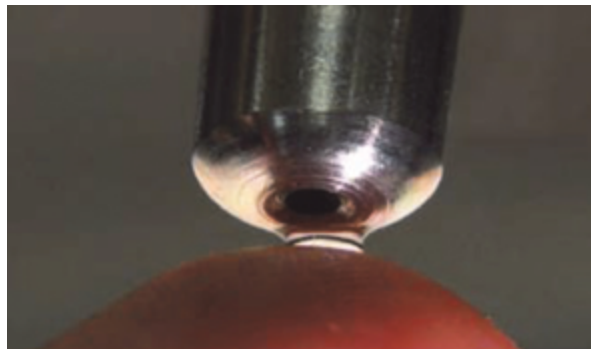

Figure 9-8 Bottle nipple with water drop (finger test to pull off the drop)

Bottle caps and their proper functioning are essential for animals and their life. All persons involved within laboratory animal facilities are committed to exercise special care.

Conclusion to 9.1 - 9.8:

Usually, the defects and damages described above do not result from insufficient product quality of items. What must be considered, however, is a careful selection and adaptation of influencing factors (items to be processed, washer, process chemicals, sterilisers, SOPs, etc.).

## 9.9 Criteria for screening damaged material

Beside the above-mentioned changes in material, a normal washing and steam sterilisation process will cause material induced deterioration over time that can make it necessary for certain items to be replaced. Therefore, these items should be scheduled for regular material fitness checks.

Note: Discarded goods do not have to be disposed of in the normal way and may have to be incinerated. This is a disposal that is harmful to the environment. In particular, goods made of plastic can be recycled and the recovered material can be used in other industrial sectors as pipe material for the production of other plastic parts. Various cage manufacturers offer take-back and recycling programmes.

## 10 Literature, standards, publications

### Normative references

- DIN 31051 (German Institute for Standardization): Physical Assets Maintenance
- DIN 4140: Insulation Work on Industrial Installations and Building Equipment – Execution of Thermal and Cold Insulations
- EN 285 (European standard for products and services): Steam sterilisation; Steam Sterilisers; Large Sterilisers
- DIN 58952: Steam Sterilisers for Laboratory Use
- DIN EN ISO 17665-1: Sterilisation of health care products - Moist heat - Part 1
- ISO 8573-1(International Organisation for Standardization): Compressed air – Part 1: Contaminants and Purity Classes
- DIN EN VDE 0100: Regulations for Building High Voltage Systems with Nominal Voltage up to 1000 V
- DIN 1986: Technical Rules for Drinking Water Installations – Drainage systems on private ground, Animal Laboratories 007, bulletin BG Chemie
- DIN 10510: Food Hygiene – Commercial Dishwashing with Multitank-transport Dishwashers – Hygienic Requirements, Type Testing
- DIN 10511: Food Hygiene – Commercial Glasswashing with Glasswashing machines – Hygienic Requirements, Type Testing
- DIN 10512: Food Hygiene – Commercial Dishwashing with Onetank-Dishwashers – Hygienic Requirements, Type Testing
- DIN 58955: Decontamination Equipment for Medical Use
- DIN EN 12353: Chemical Disinfectants and Antiseptics – Preservation of Test Organisms Used for Determination of Bactericidal, Mycobactericidal, Sporicidal and Fungicidal Activity
- DIN 10088-1: Rustproof Steels – Part 1: Index of Rustproof Steels

### Directives / regulations

- Planning and Organization of Lab Animal Facilities and Laboratories, 2015  
German Title „Planung und Organisation von Versuchstier-Haltungen und –Laboren, 2015“  
Further publications please refer to: [www.gv-solas.de](http://www.gv-solas.de)
- Appendix A of the European Council, ETS 123 Official Journal of the European Union from 30.07.2007 (2007/526/EG)  
Please refer to: [www.gv-solas.de](http://www.gv-solas.de)
- DIRECTIVE 2010/63/EU OF THE EUROPEAN PARLIAMENT AND OF THE COUCIL of 22 September 2010 on the Protection of animals used for scientific purposes  
Please refer to: [www.gv-solas.de](http://www.gv-solas.de)
- TRGS 906 – Technical guideline for the handling of hazardous materials, Directory of carcinogenic operations or procedures according to §3 paragraph 2 No. 3 GefStoffV
- TRGS 540 - Technical guideline for the handling of hazardous materials, sensitizing substances
- TRGS 553 - Technical guideline for the handling of hazardous materials, wood dust
- TRGA 120 – Technical guideline for biological agents at work - experimental animal facilities
- Directive 2004/37/EC of the European Parliament and of the Council on the protection of workers from the risks related to exposure to carcinogens or mutagens at work, appendix I, No.5
- Machinery directive 2006/42/EC

## Publications

„Leitfaden für die Praxis: Dampfversorgung zur Sterilisation von Medizinprodukten“ ; überarbeitete Neuauflage 2005. Herausgeber AK-Steri-Dampf

(Practical guide: Steam supply for sterilising medical items, revised new issue 2005 by AK-Steri-Dampf)

„Instrumenten-Aufbereitung im Veterinärbereich richtig gemacht“, „Grüne Broschüre“, 1. Ausgabe 2005. Herausgeber: Arbeitskreis Instrumenten-Aufbereitung

(Proper Maintenance of Instruments in Veterinary surgeries, Green Brochure, 1<sup>st</sup> issue 2005, by the Working Group for Instrument Processing)

AK-BWA Broschüre, 8. Auflage, 2009

(AK-BWA brochure, 8<sup>th</sup> issue 2009)

Current state of room decontamination using gaseous hydrogen peroxide, Hygiene & Medizin, 35 [6]; 204-208

„Musculoskeletal Load in and Highly Repetitive Actions of Animal Facility Washroom Employees“ 2011, Journal of the American Association for Laboratory Animal Science (AALAS) from the Helmholtz-Zentrum for Health and Environment Neuherberg and the Institute for occupational safety of the German Statutory Accident Insurance (Deutsche Gesetzliche Unfallversicherung (IFA) - former BGIA)

2003 ILAR Magazine entitled „Engineering Controls and Facility Design“- An Ergonomic Process for the Care and Use of Research Animals”.

European Society for Sustainable Laboratory Technologies (EGNATON)

Profiles for the sustainability certification of cage cleaning systems (EGNATON CERT)

<http://www.egnaton.com/de/CERT.aspx>

## 11 Terms / Definitions

### Animal facility

This term includes all rooms necessary for operating an animal facility, also those for dispensing and disposal, like animal rooms, wash-up area / processing centre, halls, storage rooms, engineering rooms, locks, and also laboratories.

### Animal housing area

The rooms in which the animals are housed.

### AOX compounds

Adsorbable organically bound halogens are generated by excess active chlorine when permuted with organic dirt components. The resulting halogenated hydrocarbons are not ecologically favourable.

### Bisphenol A

Bisphenol A is one of the monomers (reactive molecule) used for generating polycarbonate.

### Boiling delay

Please refer to: Danger to life due to boiling delay.

### Carryover

With failings in process management or deficiencies in machine construction, it is possible that residual soiling or detergent solution of a preceding washing step is carried over to already washed items.

### CFU

Colony forming unity

### Chlorine-induced pitting

Chlorine-induced corrosion of hollows in metal surfaces covered with passive layers.

**Collection bin**

When cages are emptied, the bedding is collected or temporarily stored in collection bins. These can either be big plastic bags, bulk containers or vacuum containers.

**Correction chemicals**

Additives in steam to avoid, for example, corrosion inside steam pipes.

**Danger to life due to boiling delay**

After steam sterilisation, liquids are cooled by means of “back pressure” that is significantly higher than boiling pressure. When the cooling process is finished, the back pressure is lowered to atmospheric pressure. Insufficiently cooled liquids can then have a temperature higher than boiling temperature without actually boiling. All it needs for the liquids to suddenly start boiling is a trigger. Such a trigger can be a vibration when the load is moved out of the chamber. A sudden release of steam can result in boiling over or even bursting containers. Hot liquids can be spread about. The huge mass of a steam sterilisation load poses a risk of life threatening scald burns when liquids are insufficiently cooled.

**Decontamination**

Decontamination describes the process of removing soiling (washing process) and reducing the number of viable microorganisms to a degree necessary for further processing or use of an object.

**Detergent liquor / detergent solution**

Describes the amount of tank water mixed with detergents that is circulated in the recirculation system of a washer.

**Disinfection of surfaces**

Disinfection of surfaces means a specific chemical elimination or inactivation of certain unwanted microorganisms in defined quantities. This is achieved by an irreversible act on the structure or metabolism of the microorganisms in order to prevent them from proliferating, thereby averting a danger of infection. The surfaces can be disinfected either by wiping or, when surfaces are visually clean, by spraying them.

**Dumping device**

A permanently installed or mobile station for emptying cage bases of dirty bedding. This includes passively (by gravity) and actively (by suction) operating devices (e.g. dumping hoppers).

**Electrical conductivity measurement**

The electrical conductivity of diluted solutions is a sum parameter for dissociated solutes (ions). The extent of conductivity depends on the degree of concentration and dissociation of the ions as well as on the temperature and solute-specific velocity of migration. Measuring the conductivity can help define the concentration of dissolved process chemicals.

**Environmental enrichment**

These are products added to the cages in order to enrich the living space of animals. In general, this includes all products that meet this purpose and fit into the cages, especially pulp products, wood shavings, small plastic and wood houses, wooden chewing sticks, etc.

**Ergonomics**

The science of human work performance capabilities and limits. In this context it means the interaction of man and machine, the physical impact on the operating staff in particular.

**Evaporative heat loss**

When steam sterilising, the thus generated condensate, due to evacuation, vaporises after the steam sterilisation process is finished. The condensate cools down (evaporation). For a fully drying of items, ambient heat must be fed to the process, for example from the item itself. The drying result depends very much on the available amount of heat. With bigger amounts of condensate, like in cages, there might not be enough heat left to ensure a complete drying.

**Fine dust**

Dusts with particle dimensions from 0,3 to 10 µm. These particles are respirable and can hardly be withheld by the nasal mucosa. Thus, substances that are not harmful in themselves can also pose a health risk.

**GLP**

Good Laboratory Practice

**GMO**

Genetically modified organisms

**Hygroscopic condensation/Overheating**

Hygroscopic material (e.g. bedding, feed), which was loaded extremely dry into a steam sterilizer chamber, is frequently affected by overheating. This leads to the so called hygroscopic condensation: The hygroscopic material already reached the temperature of the surrounding steam and still tries to increase its relative humidity. This is achieved through condensing steam. The released condensation heat results in local overheating. The dryer the initial state of the material the greater the effect of overheating via hygroscopic condensation.

**Items for processing**

All items to be processed in an animal facility (please refer to the figure in chapter 2).

**IVC systems**

Individually ventilated cages. This means cage systems for hygienic/allergic protection of animals and humans/surroundings. To achieve this protection, cage bases are closed and locked with tops. Individual ventilation systems allow for a proper air supply of the animals.

**LAF**

Laminar-Air-Flow

**Loading trolley**

A loading trolley is a mobile rack for loading and moving different types of items into a washer or steriliser. Different types of items and machines require different types of loading trolleys.

**MAC value**

The MAC value indicates the maximum allowable concentration of hazardous substances in form of gas, steam, or aerosols in workplace air that, according to current knowledge, pose no risk to the health of employees and are no major disturbance either. This is even with employees being exposed to them over a longer period, which means a work time of eight hours a day.

**Media**

This term sums up all utilities (usually steam and water) and process chemicals.

**Occupational risk assessment**

A workplace should be as low risk as possible. Therefore, every employer is to conduct a risk assessment of the possible threats posed in every job he/she offers. For principles and methods of occupational risk assessment, please consult the labour protection act, ordinance on industrial safety and health, and ordinance on hazardous substances as defined by your respective country. The aspects described below should be considered in particular:

- risks that occur with general job work, for example in the course of certain work procedures (assessment of the entire work routine – “synopsis”: selection/combination/interaction of different machines, hazardous substances, physical positioning, employee skills, etc.),
- risks that occur when working with hazardous substances, like detergents and disinfectants (protection level concept),
- risks that occur when handling work equipment, like machines, in interaction with, for example, hazardous substances,
- test intervals for machine parts, machines, and the overall system.

Details on occupational risk assessment can also be found in the guidelines of government safety organisations or of the regional authorities charged with the principles and methods of occupational safety.

**PAA lock**

Lock for transferring heat-sensitive products in and out of a barrier area by means of steam sterilisation. The disinfectant thereby used is peracetic acid.

**pH Value**

Diluted solutions are classified into highly acid, mildly acid, neutral, mildly alkaline, highly alkaline with the pH value as the measuring unit. The numerical scale ranges from 0 - 14 whereas values < 7 indicate the acid and values > 7 the alkaline scale. Diluted solutions with a pH value of 7 are classified as neutral.

**Process capability of bedding**

Every process is adapted to certain products, so are semi or fully automated bedding dispensing systems. Some very fibrous types of bedding, when put into containers, are prone to bridging, which makes them hard to dispense evenly. The result would be cages with varying filling quantities.

**Process chemicals**

Collective term for detergents, neutralisers, and rinse aids, added to the water in automated processing.

**Processing**

Processing means washing, disinfecting, and sterilising all items that are transferred from the processing centre (or wash-up area) to the animal housing area, including all associated emptying, filling, and transporting/carrying activities.

**Processing centre**

Please refer to wash-up area.

**Recirculation system**

In the recirculation system of a washer the spray water mixed with detergents is recirculated and thus repeatedly sprayed on the items to be processed.

**Scooping cavities**

Hollows and areas on items that are prone to accumulating residual liquid and dirt.

**SOP**

Standard Operation Procedures

**SPF area**

Area for housing and breeding specific pathogen free animals.

**Spray water**

Spray water is the water in automated washers, potentially mixed with process chemicals, that is pressure-sprayed via jets on items for processing.

**Steam sterilisation**

A validatable procedure for removing viable microorganisms.

**Thermo labile and thermo stable items**

Refer to chapter 4.5.1.1

**Titration**

Titrimetric method for determining the amount of substances in liquids (method for defining the substance concentration). Drops of a reagent of known concentration (standard solution) are added with a burette to a given substance till the concentration is even and the indicator in the standard solution shows a colour change.

**Tolerable residual moisture**

A tolerable residual moisture means single water drops (no puddles of water) adhering to items in adverse spots after being removed from the washer. Subsequent steps of item processing are not affected.

**TTI (Total theoretical impact)**

TTI value is the momentum of the water that impacts the surface of the material to be processed.

The formula for TTI is:

$$TTI = 0.024 * Q * \sqrt{P}$$

Q = volume flow / liter per minute

P = spray pressure in kgf / cm<sup>2</sup>

1 Newton = 9.80665 kgf

The higher the value of the TTI, the higher the impulse of the water which impacts the surface of the material to be treated and thus effects the cleaning performance.

As can be seen from the formula, the volume flow of the water has the greatest influence on the TTI. Information that alone defines the value of the water pressure or a high number of nozzles does not correctly reflect the facts.

With the above the manufacturer of a system can calculate the overall effect (TTI) of the nozzle system applicable to the respective cleaning system and present it as a quality criterion.

**Washing**

Removing soiling off objects to a degree necessary for further processing or designated use.

**Wash-up area**

All machines necessary for washing, disinfection, and steam sterilisation of items are located in close vicinity in the wash-up area (also processing centre).

**Work exposure limit (WEL)**

The work exposure limit (WEL) describes the limit of the time-assessed average concentration of a substance in workplace air for a given reference period. It indicates the safe concentration of a substance where no acutely or chronically harmful effects on health in general can be expected. The limit is generally based on a presumed eight hour exposure to a substance five days a week of an entire working life. The work exposure limit is indicated in mg/m<sup>3</sup> and ml/m<sup>3</sup> (ppm). (Please consult the ordinance on hazardous substances as defined by your respective country/EU standards.)

**Vapours**

Humid, warm air generated when operating an automated washer or steam steriliser.

Trespa® is a registered trademark of the Trespa International BV, Makrolon® is a registered trademark of the Bayer MaterialScience AG, Noryl® is a registered trademark of the GE Deutschland GmbH, Bakelit® is a registered trademark of the Bakelite AG.

## 12 Appendix

### Self-declaration concerning performance checking checkable attitudes of washing machines

This declaration refers to the following washing machine  
(delete as applicable):

- Cabinet cage washer
- Tunnel cage washer
- Cage-, rack- and trolley- washer
- Bottle washers

Manufacturer: ..... Type/Series .....

In terms of the above mentioned washing machine, we have fulfilled the appropriate type-test according to the AK KAB test-procedures; for this test we used the amount of test strips, that are signed in in the right columns of the table below. The test results was performed in ..... cycles.

Washing machine	Amount of processing goods as requested for the test by the AK KAB					Input-columns for the bidder Totally y test strips were used on z processing goods:	
	Cycles / duration	Cage-bodies	Stainless steel lids	IVC-Rack	Transport-trolley	During washing	during decontamination
Cabinet cage washer	3	10%*	1 pile with 3 stacked lids, test strip only in the middle, 10 % of the piles*	Not applicable	Not applicable	y = ..... z (cages) = .....	y = ..... z (cages) = .....
						y = ..... z (lids) = .....	y = ..... z (lids) = .....
Tunnel cage washer	In 15 min.	10%*	1 pile with 3 stacked lids, test strip only at the lid in the middle, 10 % of the piles*	Not applicable	Not applicable	y = ..... z (cages) = .....	y = ..... z (cages) = .....
						y = ..... z (lids) = .....	y = ..... z (lids) = .....
Cage-, rack- and trolley-washer	3	10%*	1 pile with 3 stacked lids, test strip only at the lid in the middle, 10 % of the piles**	1	1	y = ..... z (cages) = .....	y = ..... z (cages) = .....
						y = ..... z (lids) = .....	y = ..... z (lids) = .....
						y = ..... z (IVC-racks) = .....	y = ..... z (IVC-racks) = .....
						y = ..... z (trolleys) = .....	y = ..... z (trolleys) = .....
Bottle washer	3	bottles 6 per cycle, namely at these places:		Not applicable	Not applicable	z (bottles) = .....	z (bottles) = .....
						.....	.....

\*of the loading capacity



We confirm with this declaration, that during the test the AK KAB test methodology was fulfilled in all points, especially in terms of

- type and amount of test strips
- test soiling for test strips during washing performance tests
- test organism for checking the decontamination performance
- contamination for checking the decontamination performance
- evaluation of the decontamination
- positioning of test strips

and we furthermore confirm, that all our inscriptions in the tables A and B fully comply with the test report :

**A: Washing:**

Test results of AK KAB according chapter 7.2.2	Acceptance-criteria of <b>AK KAB</b>		Input-columns for the bidder		
	Not more the <b>10%</b> of the test strips are <b>slightly soiled</b>	Not more the <b>20%</b> of the test strips are <b>slightly soiled</b>	n% of the test strips are <b>slightly soiled</b>	n% of the test strips are <b>soiled</b>	n% of the test strips are <b>heavily soiled</b>
Cage bodies	X		n = .....	n = .....	n = .....
Lids	X		n = .....	n = .....	n = .....
Trolleys for transportation and storing		X	n = .....	n = .....	n = .....
IVC-racks (outside)		X	n = .....	n = .....	n = .....
IVC-filtertops		X	n = .....	n = .....	n = .....
	Acceptance-criteria of <b>AK KAB</b>		Input-columns for the bidder		
Bottles	All bottles are optically clean		....% of the bottles are .....		

**B : Decontamination:**

Test results of AK KAB according chapter 7.2.2	Acceptance-criteria of <b>AK KAB</b>		Input-columns for the bidder	
	A reduction of > 5lg-steps must be given at 90% of the used test strips		At y % of the used test strips a reduction of z lg-steps was registered	
Cage bodies	X		y = .....	z = .....
Lids	X		y = .....	z = .....
Trolleys for transportation and storing	X		y = .....	z = .....
IVC-racks (outside)	X		y = .....	z = .....
IVC-filtertops	X		y = .....	z = .....

**Herewith we declare, that the offered washing machine completely fulfills the test specifications of AK KAB according to the above given data.**

**This (self-) declaration is based on a test report of ..... (date), that was performed by**

..... (test institution).

**In case that our quote would be short-listed, we are able and willing, to present this test report within 6 labour-days.**

.....  
 Town Date Signature and name in printed characters

Company stamp:

**Final provisions:**

1. This brochure does not replace manufacturers' instructions for processing of cages and other items.
2. Copyright Arbeitskreis Käfigaufbereitung AK KAB (Working Group for Cage Processing). All rights reserved. No part of this brochure may be reproduced in any manner without written permission from the AK KAB. This includes figures, pictures, and text.
3. No advertising may be added to this AK KAB brochure. That applies to advertising supplements, as well.
4. This brochure was compiled with great care. Yet, the members of the AK KAB cannot be made liable for potential mistakes.

This brochure was handed to you by: